

Electronic Pattern Sewing Machine Control Panel Instruction Manual

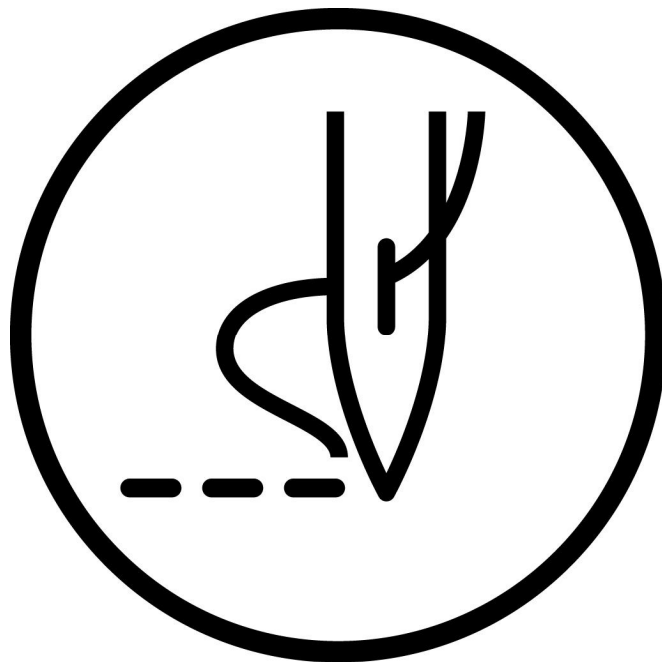







Shenzhen Smarter Technology Co., Ltd.

Catalog

【1】 Set up sewing data method.....	3
(1) Straight line.....	3
(2) Input curve.....	6
(3) Input circle.....	10
(4) Input curve.....	11
(5) Input polygon.....	16
(6) Point input.....	18
(7) Input code data.....	20
(8) Reinforcement (start / end reinforcement).....	24
(9) Reinforcement (overlapping reinforcement).....	26
(10) Multiple seam.....	28
(11) Offset sewing.....	30
(12) Zigzag stitching (with overlapping reinforcement).....	32
【2】 Comprehensive sewing type table.....	35
【3】 Call graph function.....	38
【4】 Modify mode.....	39
(1) Modify mode function.....	39
(2) Exit modification mode.....	40
(3) Change to in situ transfer data.....	41
(4) Modify sewing starting position.....	42
(5) Delete a stitch (delete the specified pin count).....	44
(6) Delete a stitch (delete the specified location after all stitching).....	46
(7) Add a stitch (add a sewing).....	48
(8) Add a stitch(Add the same sewing).....	50
(9) Modify the sewing position (after the data is connected to the fixed position).....	52
(10) Modify the sewing position (after the data position is connected to the mobile).....	54
(11) Modify a paragraph (change the front / back data).....	56
(12) Modify a paragraph (add new data to the front / back data).....	58

(13) Section modification 1 (linear input).....	61
(14) Section modification 2(Polygons, arcs, curves).....	65
(15) Section modification 3(zigzagsewing input).....	69
(16) Section modification 4(change data).....	71
(17) Modify the needle distance (the number of the specified number of pins).....	76
(18) To modify the needle distance (all the steps after the specified position).....	78
(19) Modify the needle step speed (all parts after the specified position).....	80
(20) Modify the needle step speed (all parts after the specified position).....	82
(21) Modify code data (add code data).....	87
(22) Modify code data (delete code data).....	87
【5】 Data transformation model.....	88
(1) Main data conversion mode.....	88
(2) Entry conversion mode.....	89
(3) Exit conversion mode.....	89
(4) Recognized in the image on the screen (conversion mode).....	89
(5) Zero correction.....	90
(6) Reinforcement (start / end reinforcement).....	92
(7) Reinforcement (overlapping reinforcement).....	94
(8) Zigzagsewing.....	96
(9) Graphics zoom in and out.....	98
(10) Symmetry (mirror image copy).....	101
(11) Rotate.....	103
(12) Deviation.....	105
(13) Multiple.....	108

[1]. set up sewing data method

Basic		
Function	Key	Introduce
Straight line [1]-1		Two inputs: the current position (input) and the new input point
Arc line[1]-4		Three point input: an arc is established between the current level (input) and two new input points.
Circle[1]-8		Three point input: a circle between the current bit (input) and two new input points.
Curve [1]-11		Build a curve across the current bit (already input) and the input point (up to 63 points).
Polygon [1]-16		Connect to the current bit (input) and the input point (up to 63 points) to create a polygon.
Point [1]-20		The input point: once a coil, the distance between the points must be in the 12.7mm.
Code [1]-23		From the code data table to select and enter the code data.

(1)Straight line

Operating points

* Specify linear input ()

* Enter two points (to establish a line between the current bit) and the new input point.

[Example] Will create the following types of graphics data.

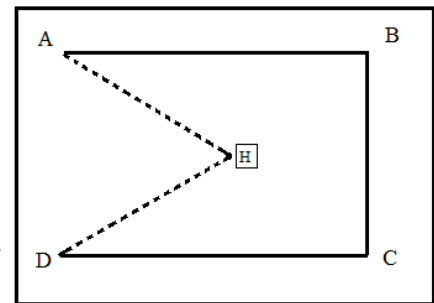



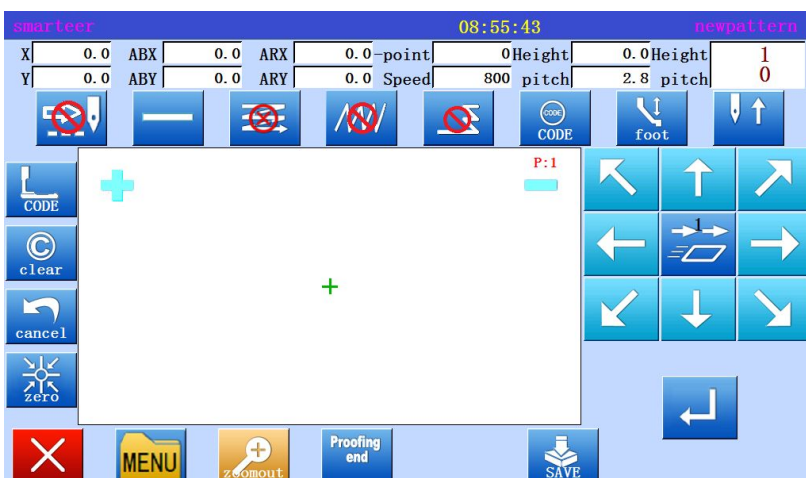

Operational details

1. Enter the transfer data to a point



* According to the standard screen

 and  in the data set on the input screen finish different settings, press  to enter a input interface.

* Press the arrow key to open the seam point (if the origin of the opening, press the air to the  state, press  to open the seam point.

* Press the arrow keys to move to a point.

2、 Set the transfer data to A points

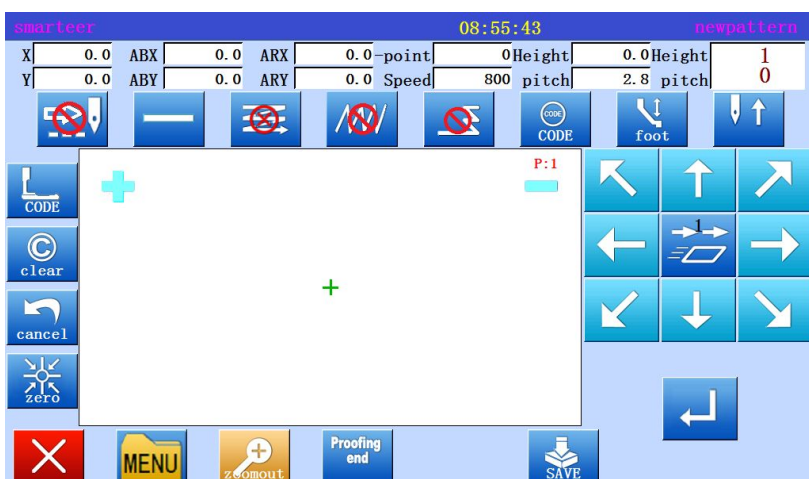

* Confirm the amount of movement

[Example] X: -0030.5 Y: +0000.0

* Press  to set the data

(Establish data transfer data to A point)

* Removal of movement

X: -0000.0 Y: +0000.0

* Air feed into “”

3、 Enter the B point of sewing

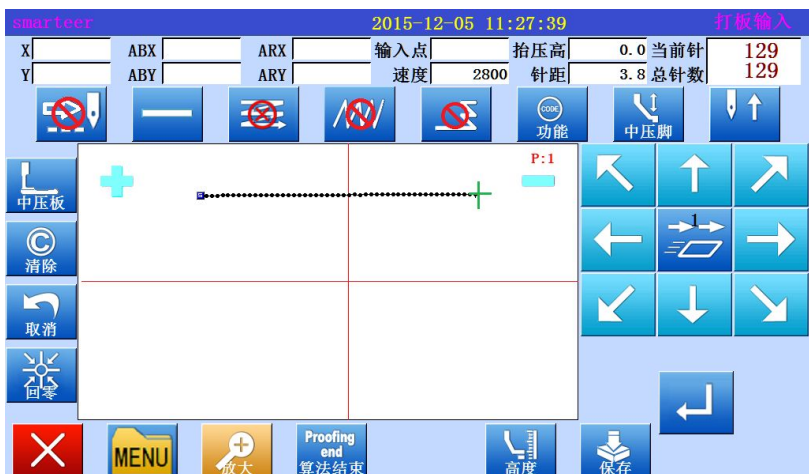

* Press the arrow keys to move to the B point.

* Press  to set data.

* Linear sewing data set up to B point.

4、 Input sewing from C point to D point

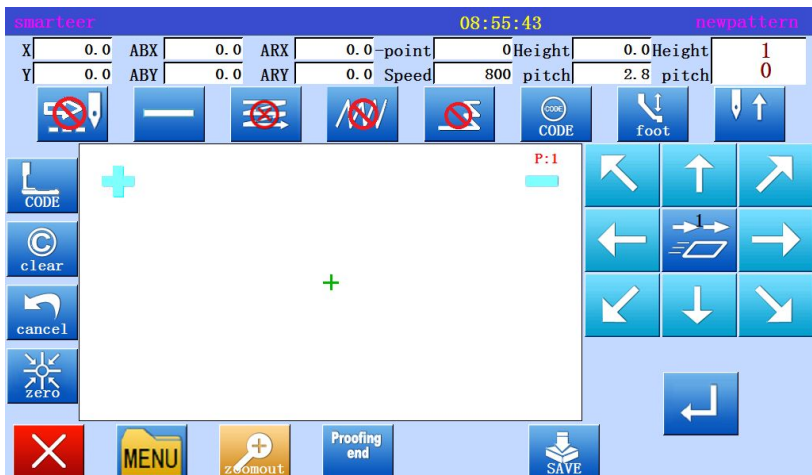

* Press the arrow keys to move to the C point.

* Press  to set data.

* Linear sewing data set up to C point.

* Press the arrow keys to move to the D point.

* Press  to set data.

* Linear sewing data set up to D point.

5、 Confirm sewing data, add cut line

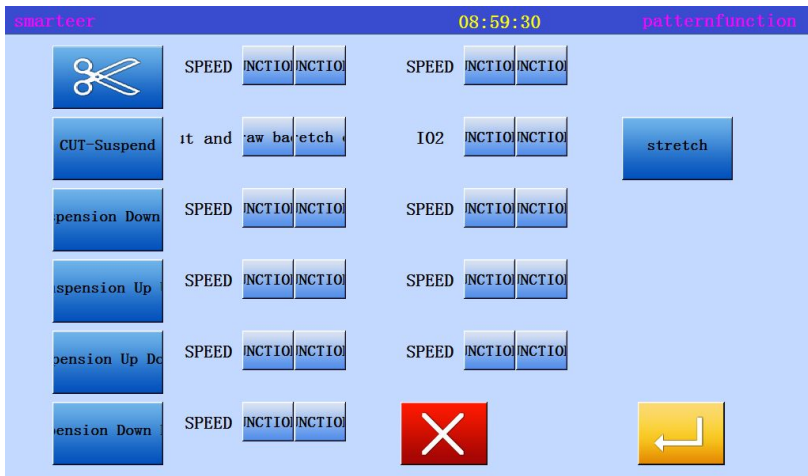



* Need to cut the line, press the  key, the need for functional data can be selected in this interface to confirm its function.

* Press  to set data.

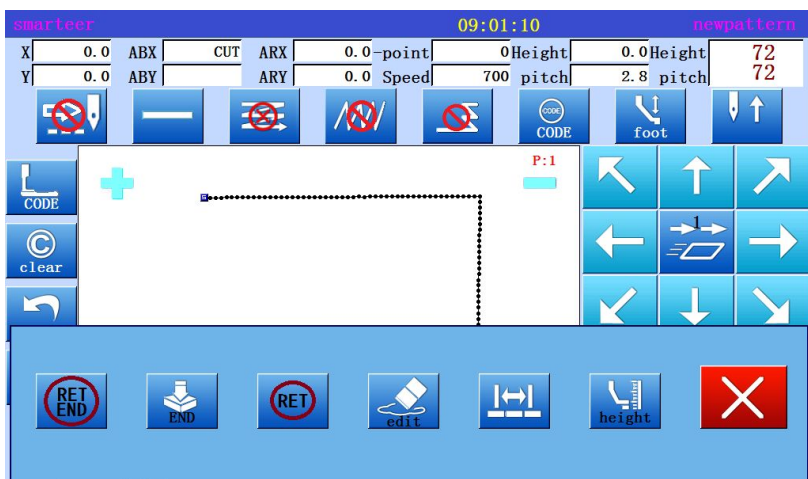
6、 Enter the return / end code



* According to "directory". 

* By  will be built to the original data and the end of the transfer of the code.

* There will be some tips that are returned to the original position.

* There will be a message indicating that the data is being set up, and then the standard exception is re established.

7、 Confirm save



* Confirm that the data is correct, store the data. Reference [5] to read, write and delete data (disk)

And [6] to read, write and delete data (memory).

8、 Confirm the data

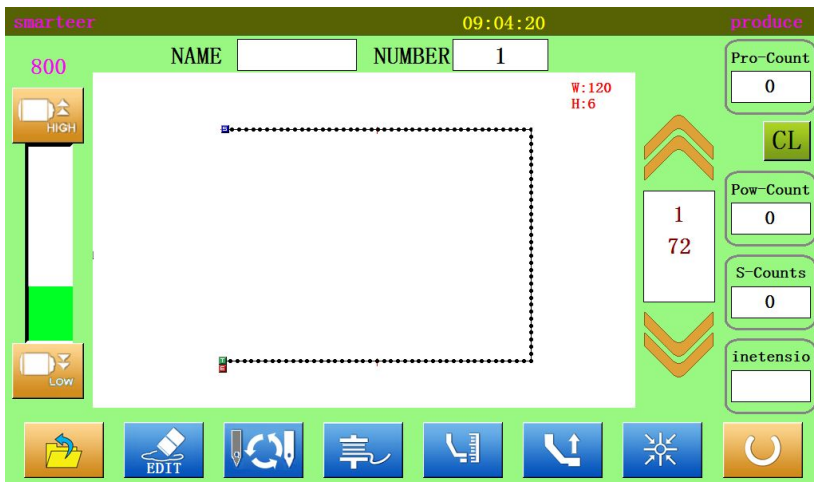

* Confirm the data, press the shift key



The movement of the sewing machine will be confirmed. (even if the data entry is not completed, if the last data entry is set up, the data is set up, it will also confirm the motion).

(2) Input curve

Input points

* Specified arc input 

* Enter three points (create an arc, pass through the current position (already entered), and two new input points).

[example] will create the following types of schema data. Select "write from directory".

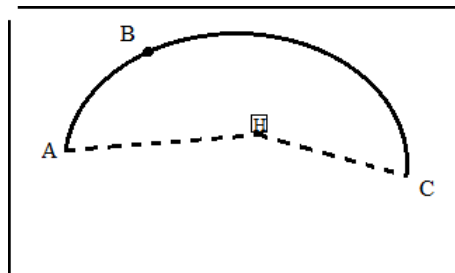

Operational details

1、 Enter the transfer data to the A point

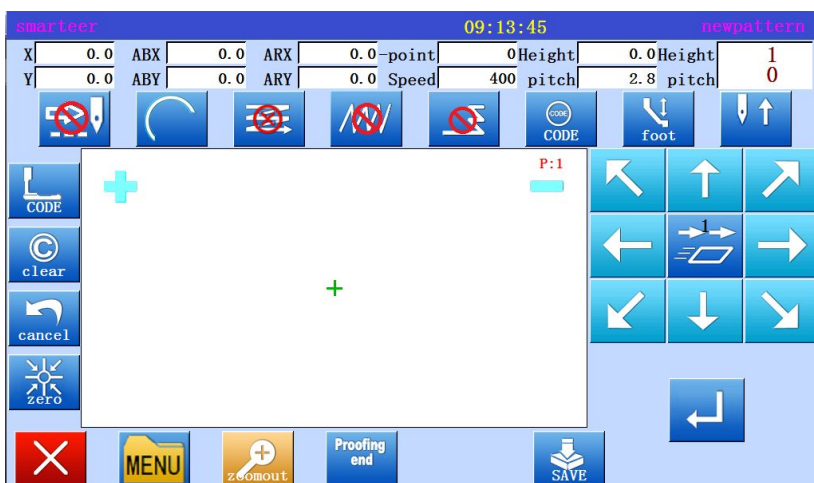

* In a screen, press  keys to

switch to 

* Press the arrow keys to move the A point (to the A point).

Transfer data set to A point

* Can confirm the number of sports.

* Press  to set the data.

* Transfer data to A point.

2、 Change input method

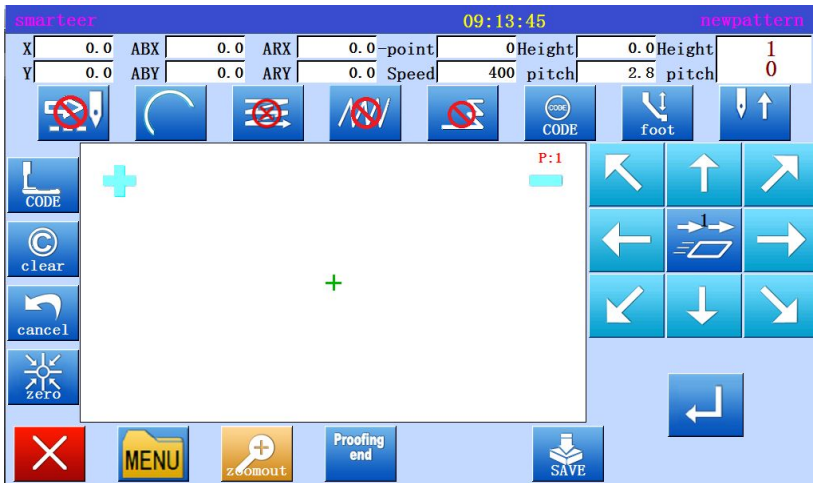

* If the sewing type is not an  arc input

(if the type is  a linear input)

Press  key to change the type.

3、 Specified arc input

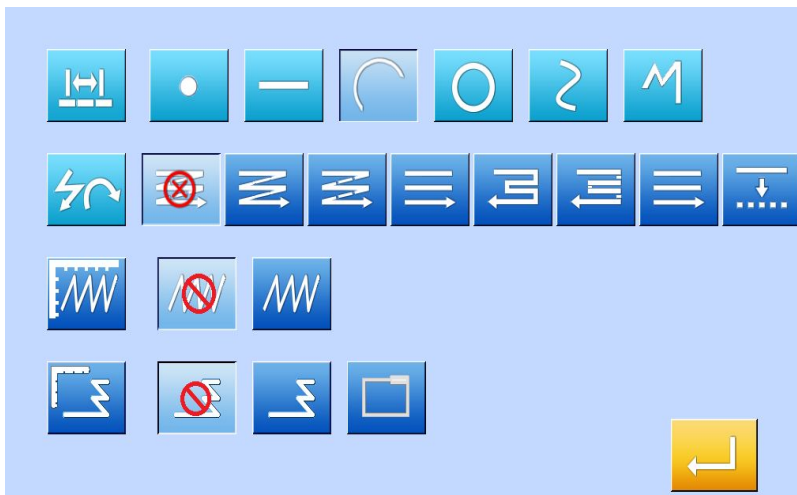

* Press ,

* The system will return to the input interface board.

4、 设定 B 点和 C 点

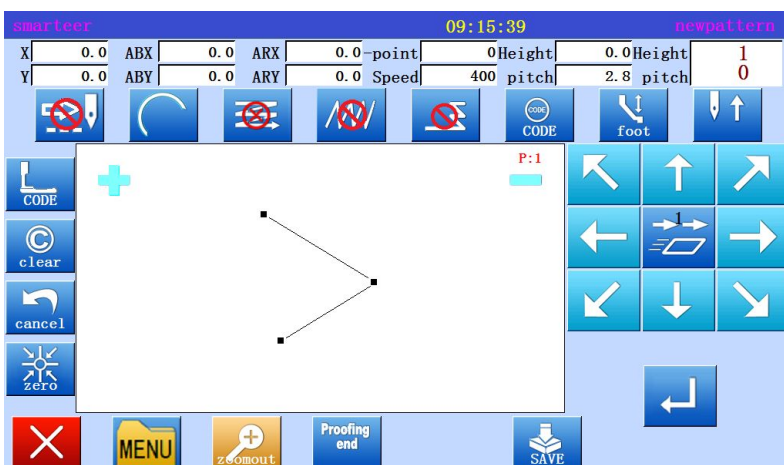

* Press the arrow keys to move to the B point.

* Confirm the number of moves.

* Press  key to determine the B point.

* Press the arrow keys to move to the C point.

* Press  key to determine the curve input.

5、 Create arc input data

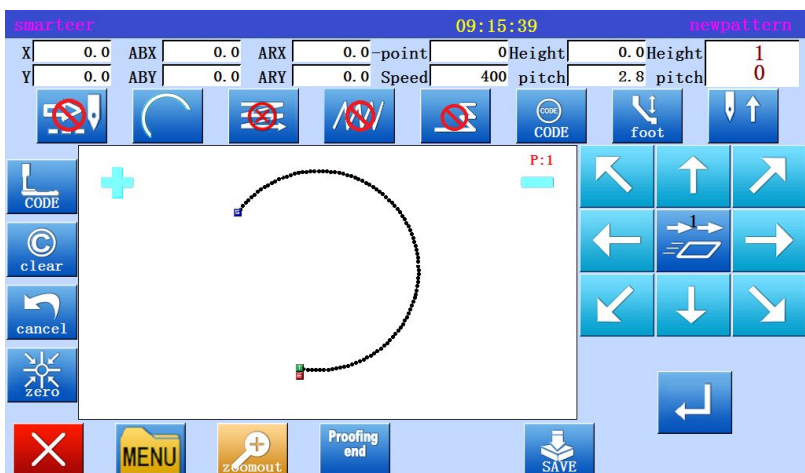

* Need to cut line, press , return to the C point, the data into the screen.

*  Press W to set up the input data, (will set up an arc)

* There will be a message indicating that the data is being set up.

6、 View pattern

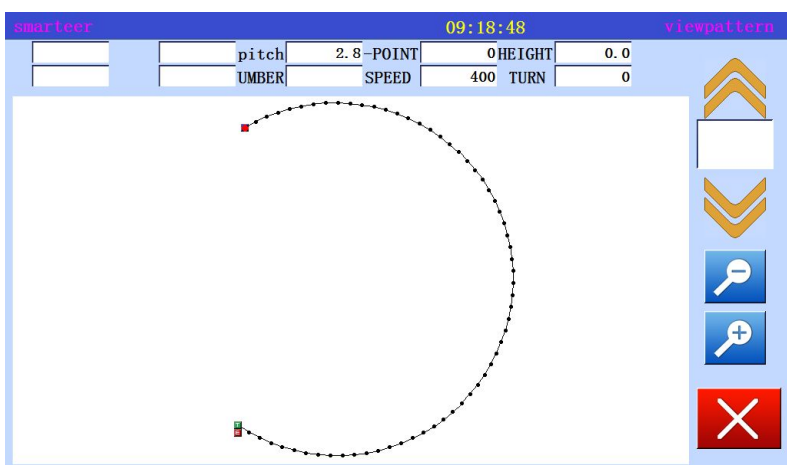

* Confirm the data, press the shift key



This will confirm the movement of sewing machines. (if the data is not completed, if the data is entered on a set, the same can be confirmed).

* If confirmed data are correct. Save data.

* If you have to modify the data,

Press , back to the new pattern interface.

7、 Enter the return / end code

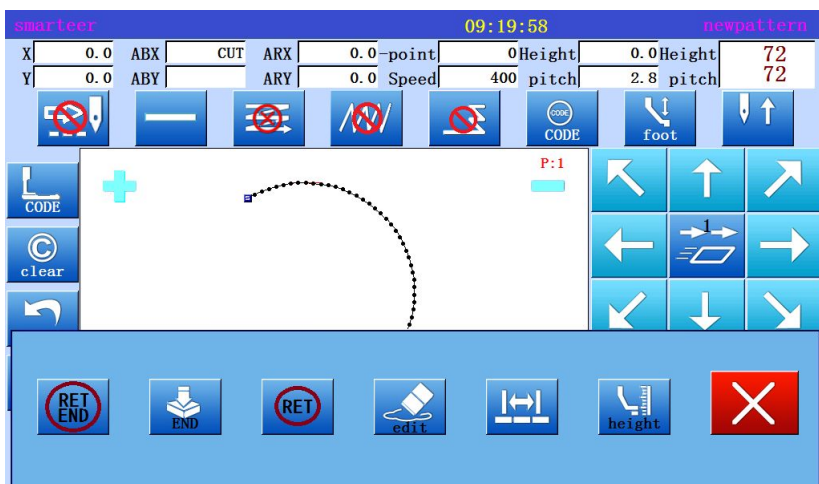

* Press .

* Press  key (will be built to the original data and save the space).

* Press  to enter the view pattern interface

Memo A interface to display the current input "arc" or "Circular" image button.

(3) Input circle

Operating points

- * Specify a circle input.
- * Enter the three point (create a circle, pass through the current position (has entered), and two new input points).

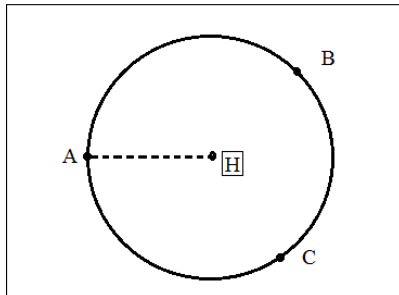

[example] will create the following types of schema data.



Operational details

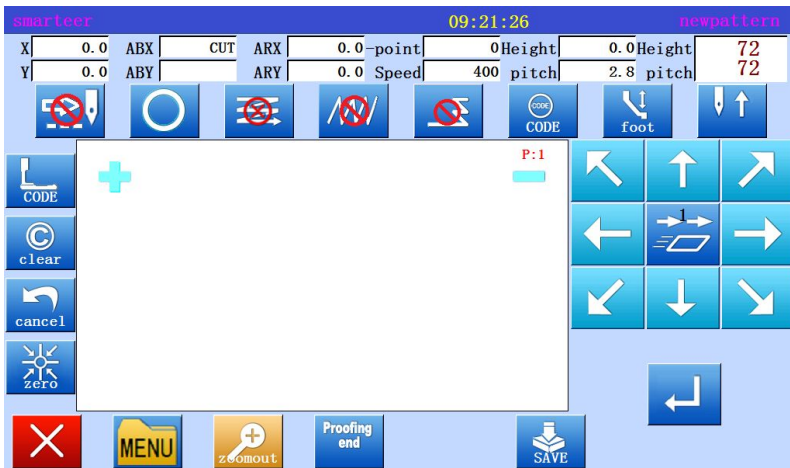

1、 Enter the transfer data to the A point

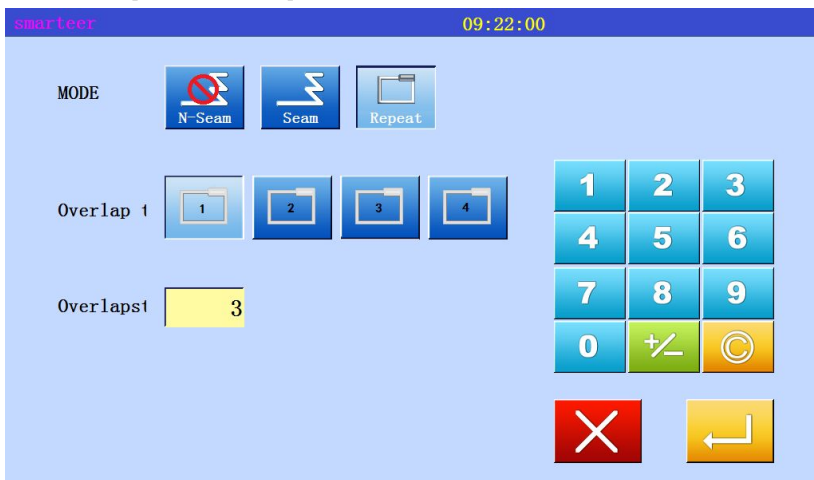

- * Press the arrow keys to the A point position, press  to select the screen on the screen, press , press  to confirm the A point.

2、 Set A point to B point of the transfer data



- * If you need to reinforce the  input interface, select the number of times and the number of pins on the  screen, press  key to determine the data.

3、 Set A point to B point of the transfer data

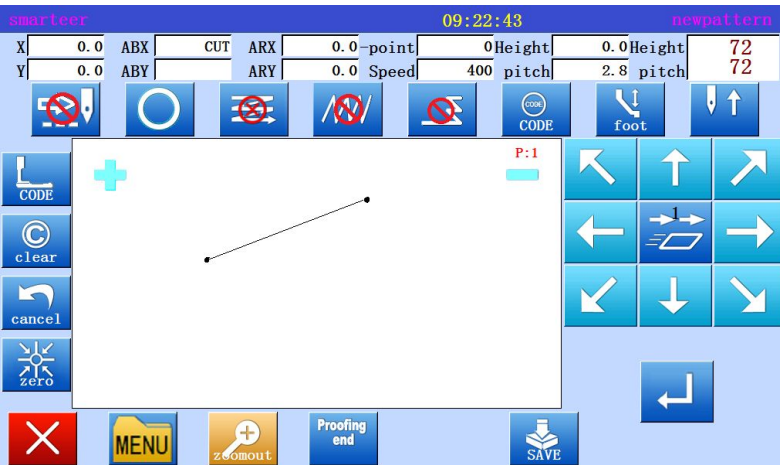

* Press the arrow keys to move to the B point,

Press  to determine the A point

4、 Set B point to C point

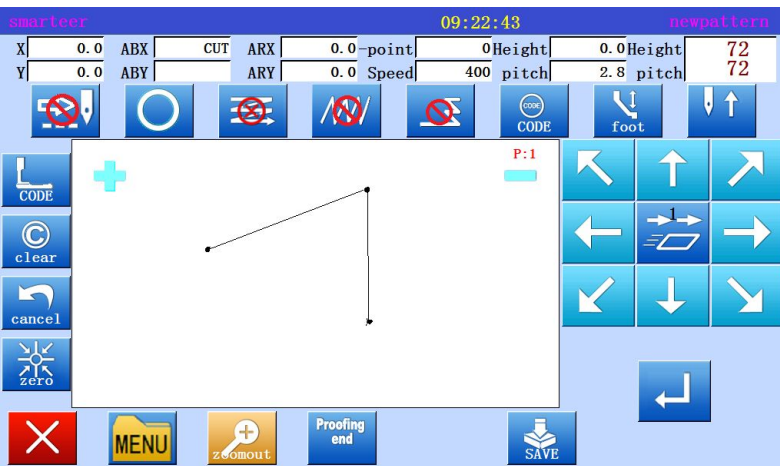

* Press the arrow keys to move to the C point,

Press  to determine the C point.

5、 Create circle input data

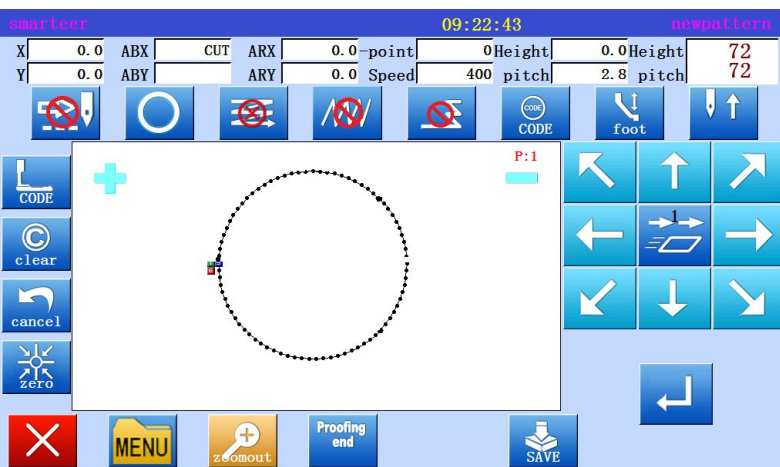

* Confirmation message "set up a circle".

* If the input highlights after the  will produce AB two points for the diameter of the circle.

* Press  key to select the cut line.

6、Complete circle input

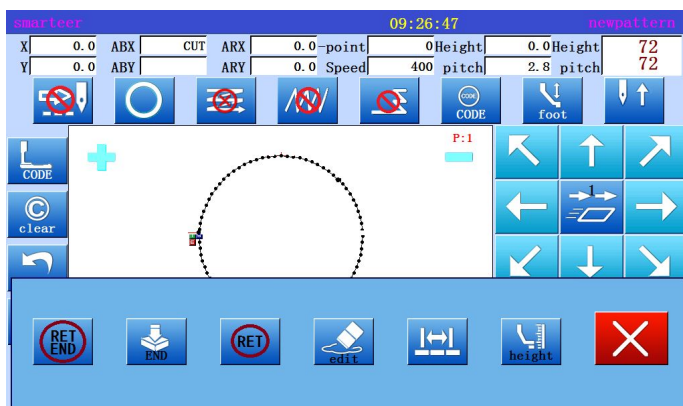

* Press .

* If you need to end, press  to save the data.

* If you need to return to the origin location and then end, press  (will be built to the original data and the end of the transfer of the

code).

7、Confirm save data



* Will appear to save the prompt, according to the pattern to fill in the number information Will appear to save the prompt, according to the pattern to fill in the number information.

(4) Input curve

Operating points

- * Specified curve input
- * Can be entered as many as 64 points (set up a curve, through the current position and the point of entry)
- * In the corner inserted under a corner symbol, continuous output curve.
[example] will create the following types of schema data.

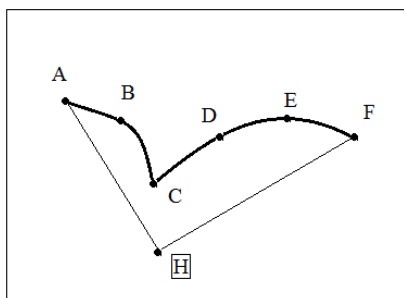

A corner symbol is set at C point.

Setting pin distance 3.0mm-10.0mm.

Operational details

1、 Enter the transfer data to the A point

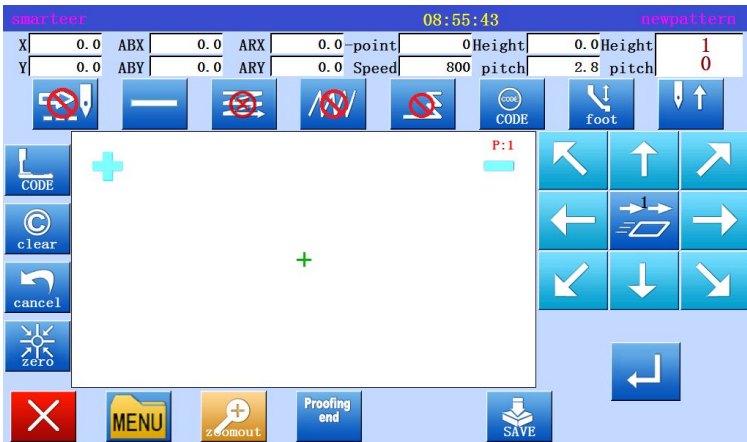

* Press the arrow to move to the A point.

* Check the code even to "move".
If you set the code to be different, press the set code to "move" .

* Position to determine, press  key

2、 Specified curve input



* Changing sewing type to "curve input",
press line setting key.

* Press ,

* Press , Setting data.

* The system will return to the interface board.

3、 Set B point

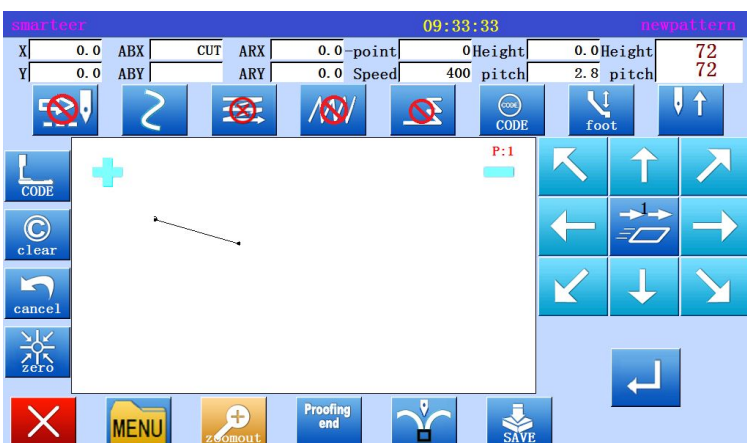

* Press direction key to move to B.

* Press  to determine the B point.。

4、Set C point

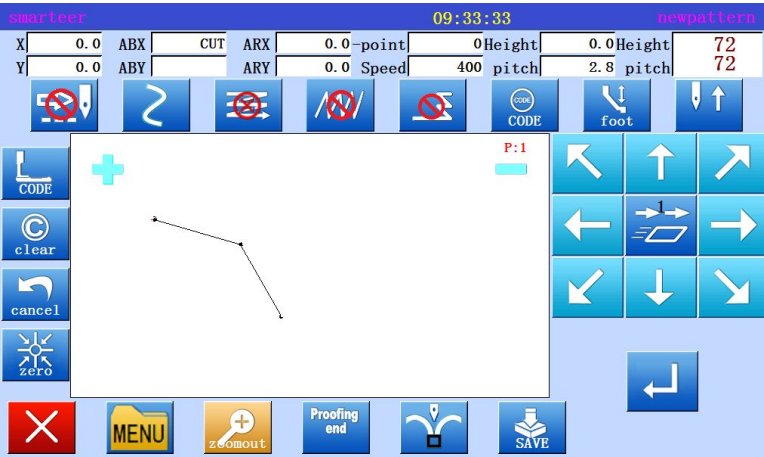



* Press direction key to move to C.

* Press , decide C point.

* And then press , to enter the turning point (breakpoint).

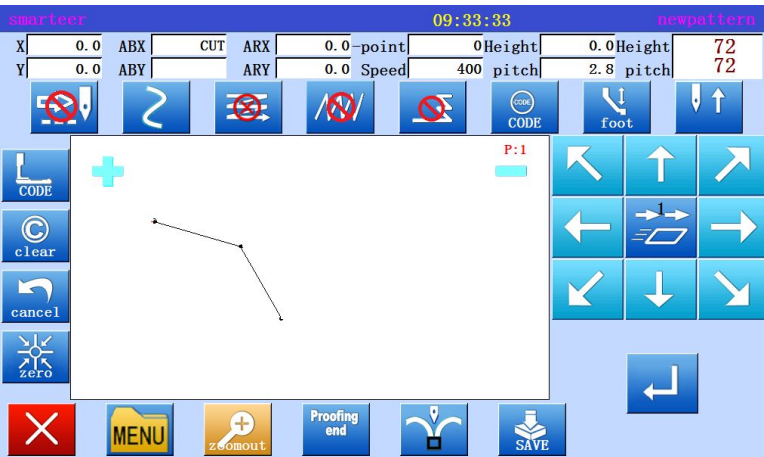
5、Insert point delimiter



* If the data is not generated, the C point turning point press  key to generate the A to C curve data.

* Press , the turning point will be set here.

6、Set D point, E point and F point, set the curve input.

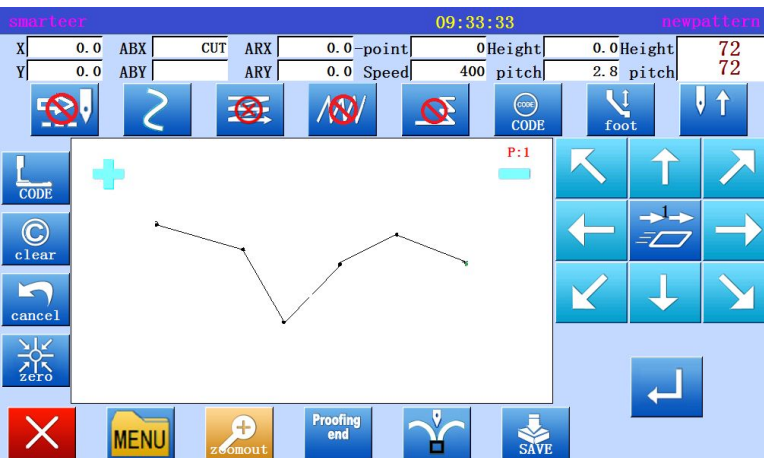

* Press the arrow keys to move to the D point.

* Press , decide D point.

* Press the arrow key again and move to the E point.

* Press , decide E point.

* Press the arrow keys to move to the F point.

* Press , decide E point.

* Complete all point data

7、Build curve

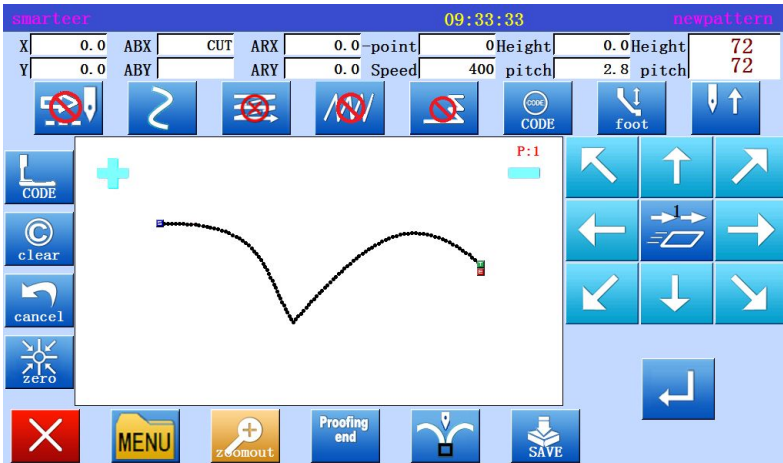

- * At the end of the acquisition point, the direct press **Proofing end** key to generate the C to F curve data.
- * If you do not need to cut the line, save the data directly by **SAVE** key, choose to save the data.

8、Complete the establishment of curve input

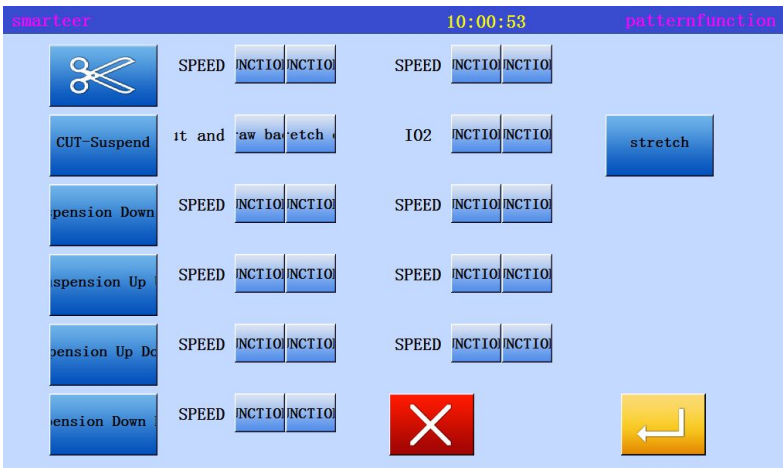

- * If the cut line, press the **CODE** key, select the cut line.

9、Enter a return / end mode

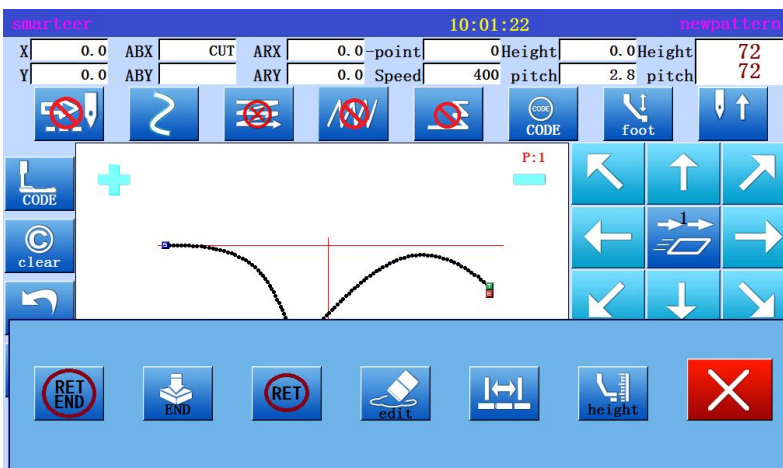

- * Press **RET END** (will be built to the transfer of data in situ data and the end of the code).
- * There will be a preservation of information, indicating that the data is being built, and then re emergence of the storage interface.

10. Validation data

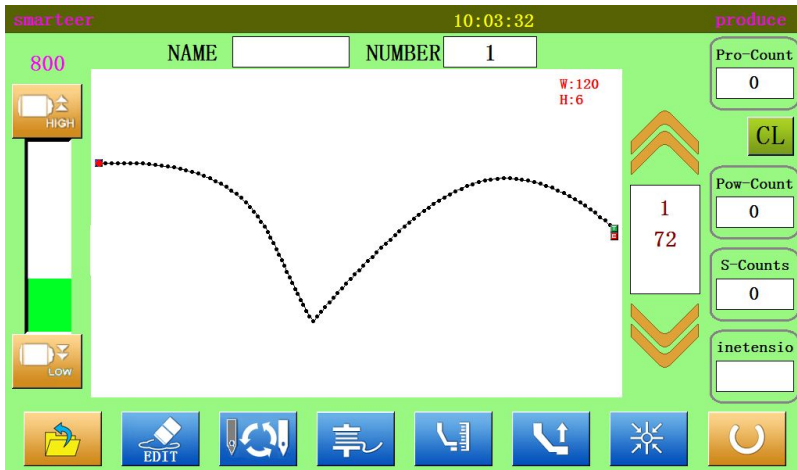

* Confirm the data, press , so that the sewing machine can be confirmed to move.◦

* If the data has to be modified, modify the sewing data.

Be careful

If the distance between the starting point and the end point of the curve is less than 0.5mm, the pattern is regarded as the "closed pattern", and the starting point and the end point will be automatically set to the same value.

Input curve warning

1、Such as the following shape data, you can continue to curve input, through the elbow is pointed in the place to choose a corner point.

(this can also be applied to non persistent points, such as offset sewing, multi-layer sewing, and reverse stitching).

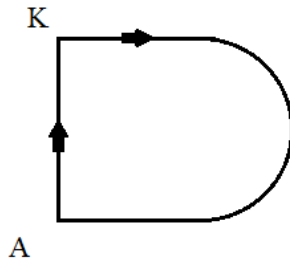

2、When setting up a curve to enter data, a highly accurate data is established by entering a number of points on the curve. So, although the trouble spot, as much as possible to enter a number of points.

Example 1 enter a point that is close to a circle or curve, as shown in figure, enter 5 points or more in 90 degrees.

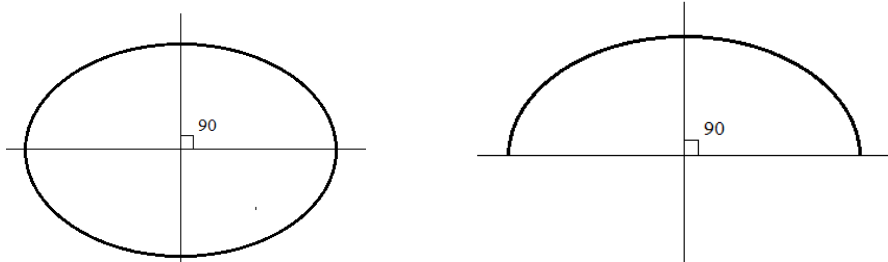

Example 2 as shown below, when the curve changes from a slow to sudden (a little bit straight up), enter as many points as possible.

(5) Input polygon

Operational details



* Specify multiple input

* Can be entered as many as 127 points (create a polygon, connect the current position and the input point)

[example] will create the following types of pattern data.

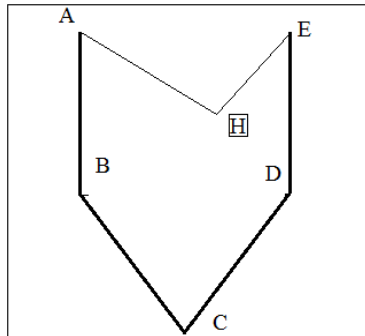

Operational details

1、 Enter the transfer data to the A point

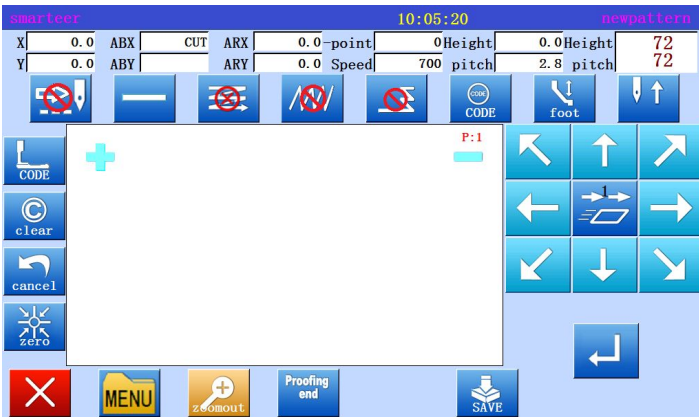

* Press the arrow keys to move to the A point.



* Press to set data.

* Will set the A point to the mobile data.

* To change the sewing type to the polygon input"

Set key by input mode. (in this case, press



the key.)

2、 Enter the transfer data to the A point

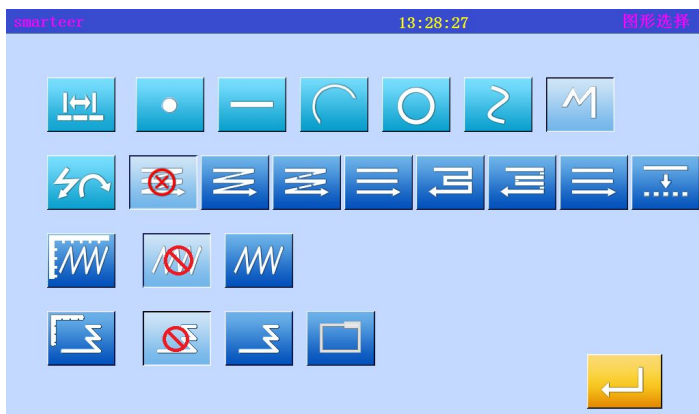

* Press





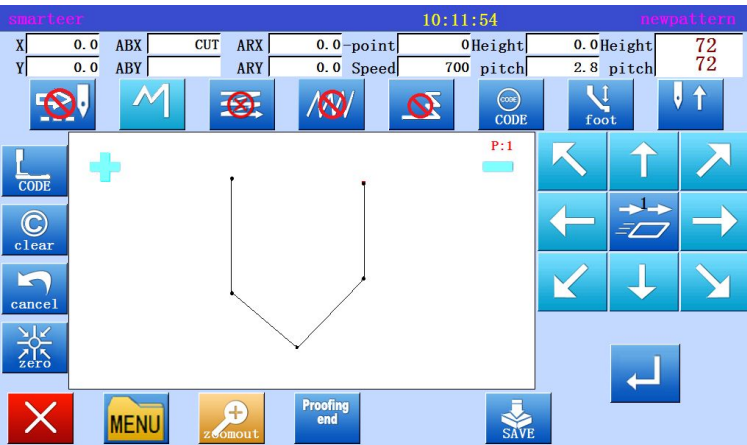

* Press to set data.

* The system will return to the input board".

3、 Set B point, C point, D point, E point



- * Press the arrow keys to move to the B point.
- * Press , determine the B point.
- * Press the arrow keys to move to the C point.
- * Press , determine the C point.
- * Press the arrow keys to move to the D point.
- * Press , determine the D point.
- * Press the arrow keys to move to the E point.
- * Press , determine the E point.
- * After the completion of all points to enter

the data, press  again, the establishment of data.

* Will appear the data to establish the confirmation information "to produce the line segment information".

* Press , to return to the last point of the input screen.

* press , start building polygon input data..

* There will be a message indicating that the data is being set up.

4、 Create polygon input

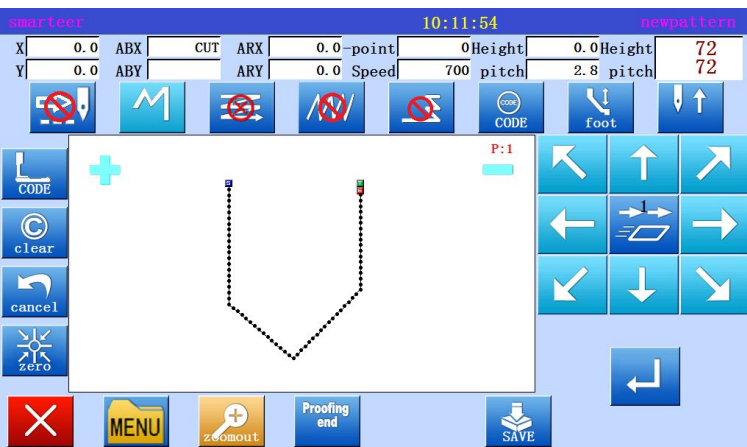

* Will appear the data to establish the confirmation information "to produce the line segment information".

* Press , to return to the last point of the input screen.

* Press , start building polygon input data.

* There will be a message indicating that the data is being set up.

* press "directory" key.

(6) Point input

Operating points

[example] will create the following types of pattern data.

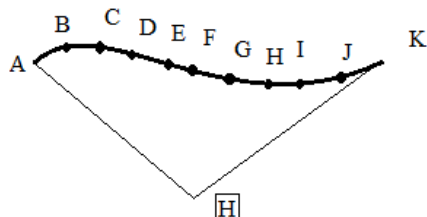

Operational details

1、 Enter the A point of the mobile data

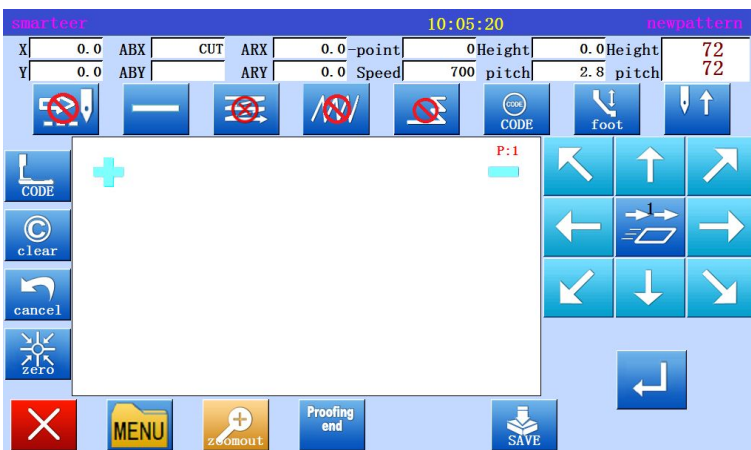

* Press  (on "standard screen"). After making a variety of different settings on the data set input screen, will open the direction of the key screen".

* Check code is set to "transfer". If you set the different code, press , and set the code to "move".,

* Press the arrow keys to move the A point.

2、 Set mobile data to A point

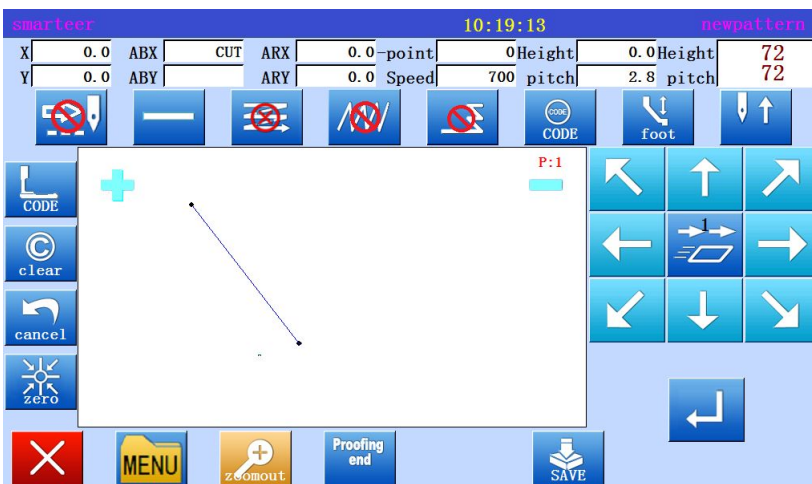

* Mobile number can be confirmed.

* Press  to set data.

* Change the sewing type to the "point", set the key according to the input method. (in this case, press the  key.)

3、Specify point input

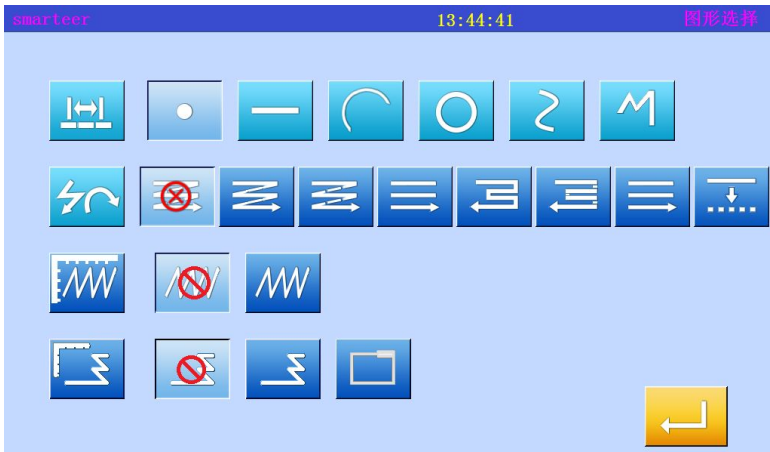

* Press .

* Press  to set data.

* The system will return to the arrow input screen".

4、Set from B point to point K

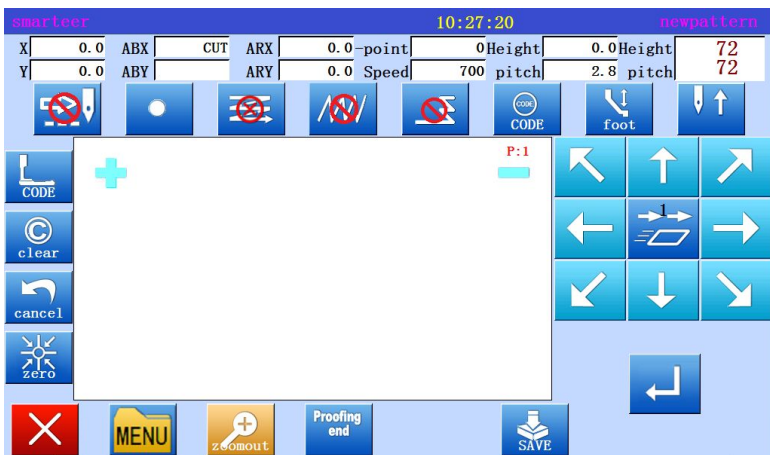

* Press the arrow keys to move to the B point.

* Press , determine the B point.

* Press the arrow keys to move to the Cpoint.

* Press , determine the Cpoint.

* will re appear "direction key screen", so press the arrow keys to move to the D point in the same way, to the point of K.

* Press .

(7) Input code data

Operating points



- * Specify code data entry
 - * From the code data table to select and enter the code data.
- [example] will create the following types of pattern data.

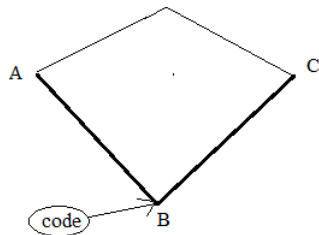

- * Input the "machine needle upper pause" code in the B point between A-B point line and B-C point line.

Memo

When you enter a straight line, circle, arc, or polygon, you cannot insert code data. If you want to enter, add the code data with a modified pattern (as shown in the example, the input line is possible.)

Operational details

1、 Enter a straight line from the A point to the B point.

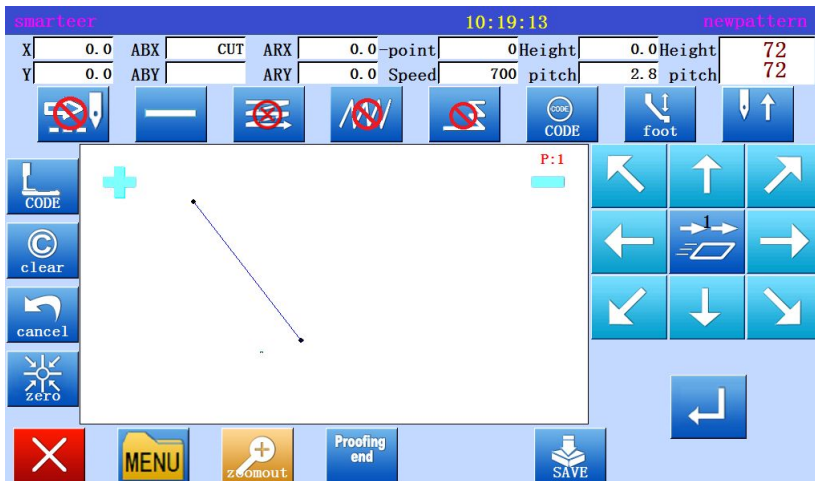

- * The use of linear input procedures, enter a point from the point of B to A points of a straight line.



* Press

2、 Enter the code data (machine needle upper pause)

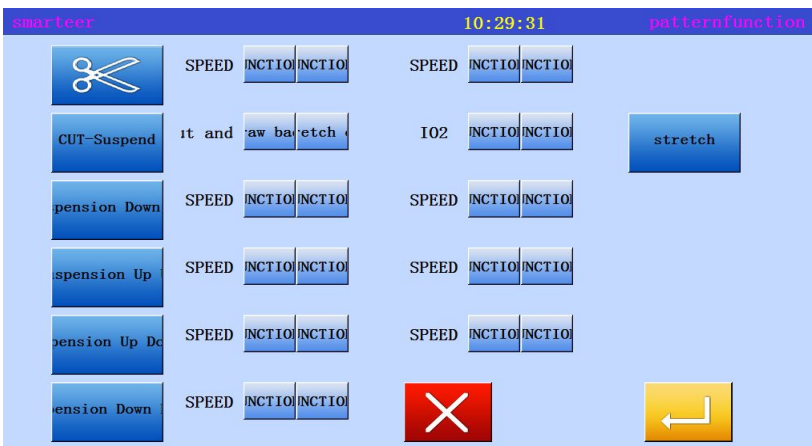

* Press



* Press to set the code.

- * The system will return to the arrow

input screen".

3、 Enter a line from B point to point C

* The use of linear input procedures, enter a point from the point of C to B points of a straight line.

4、 Enter the return / end code



* From this screen you can set up the various parameters of the code input.

“FEDS” (transfer data update)

“ASRT” (stop auto start)

... Enter numeric values from the numeric keypad.

“ATUM” (material thickness)

...Select one of the following three types.



0-3mm



3-6mm



6-8mm

“HEVI” (Weight of pressure plate)

... Select one of the following types



standard



Slightly

heavier



heavy

Code data sheet

Code abbreviation	function	Code abbreviation	function
TRIM	Thread trimming	FUN1	Function code 1
USTP	Machine needle upper pause	FUN2	Function code 2
DSTP	Machine needle lower suspension	FUN3	Function code 3
ZHP	Second in situ	FUN4	Function code 4
BAT	Long pin basting	FUN5	Function code 5
FEDS (*)	Mobile data speed	FUN6	Function code 6
ASRT (*)	Automatic start stop	FUN7	Function code 7
ATUM (*)	Material thickness	FUN8	Function code 8

HEVI (*)	Weight of pressure plate		
----------	--------------------------	--	--

BAT use method, (sewing) the line is more than 12.7mm code

[example] will create the following pattern.

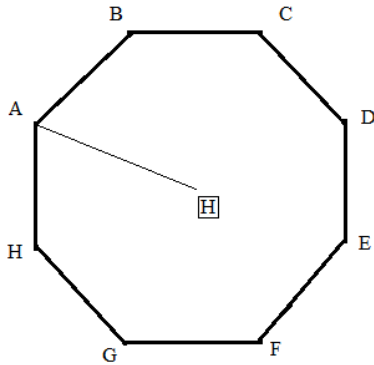

However, this function should be different from the sewing materials, such as special sewing materials set by pressing foot BPF"

1、 Move to A after the input "BAT" code.

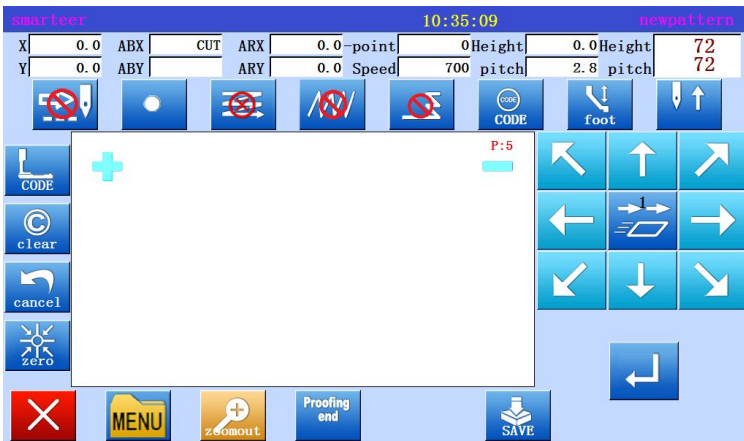

* Press  功能。

2、 Code selection screen set code selection

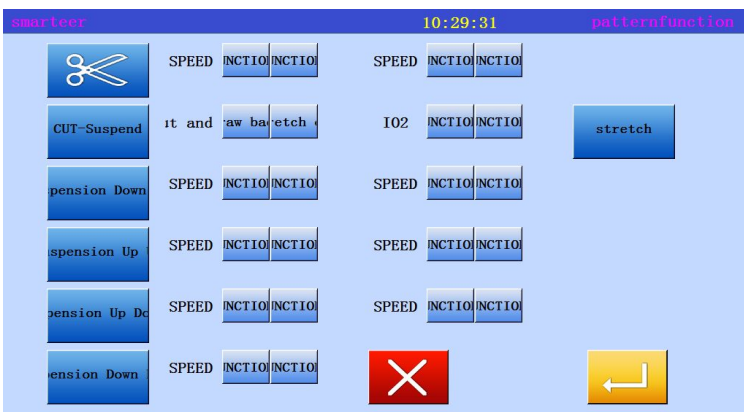

* Press  功能。

* Press  key to determine.

* System to return to the arrow input screen.

3、 Arrow input screen

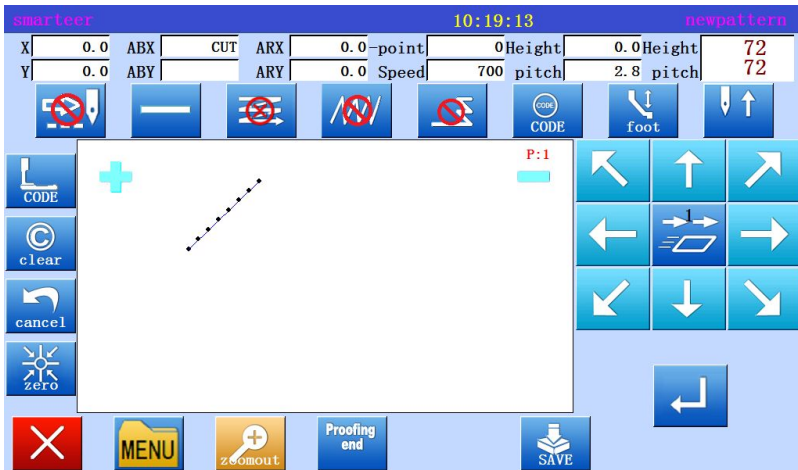

* When you enter the "skip" code, the screen will change the input mode, not the sewing input mode.

* Enter the transfer data to the B point.

* When you enter the "skip" code, H points to the A point, and the data will be repeated.

4、 Enter the pattern data before the end of the code.

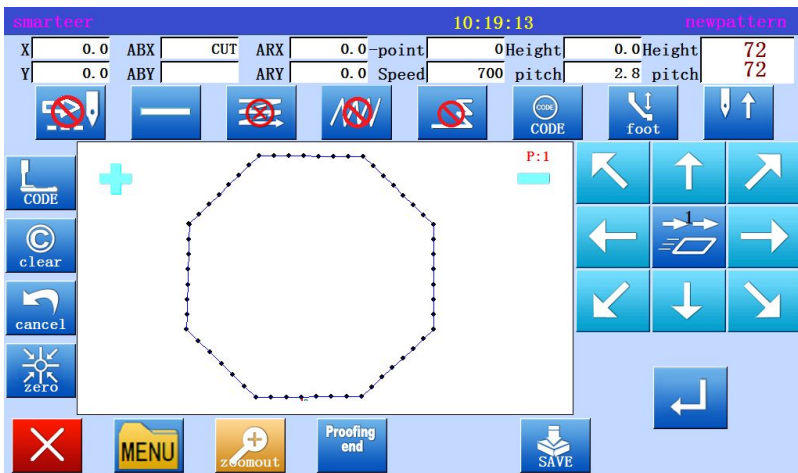

* When entering the "skip" code, do not complete the sewing data input, do not press the end of the code.



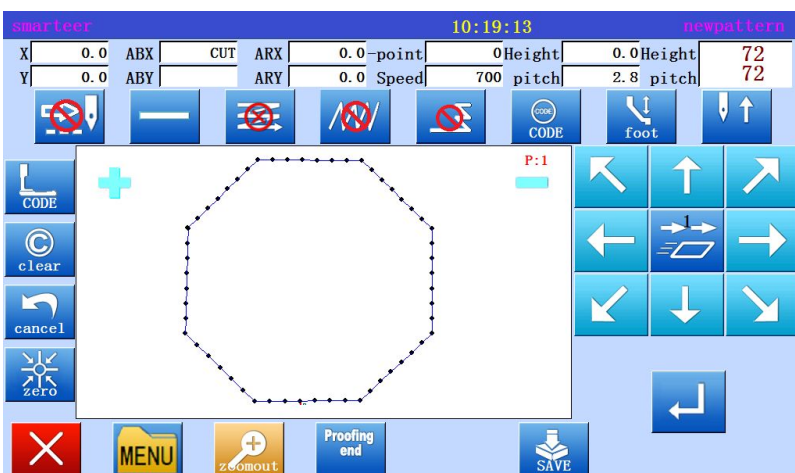



5、 Complete data entry and return to the origin.



* Complete the input to the end.

Application input

Can perform a wide variety of sewing, including seam end reinforcement, multi-layer sewing, offset sewing and man shaped sewing. Through the synthesis of the basic input and these types and easy to establish a variety of different sewing data. Refer to [10] chapter "sewing type table". Note: the application input can not be combined with the point input to enter data.

Function	Button
Reinforcement	Start / end Reinforcement 
	Overlapping Reinforcement 
Multiple sewing	Multiple sewing (mobile connection) 
	Multiple sewing (sewing connection) 
Sewing offset	
Chevron sewing	

(8) Reinforcement (start / end reinforcement)

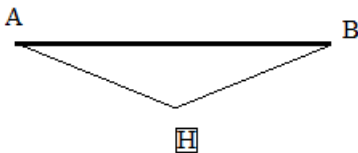

In the input line, the beginning and the end of sewing will n mode and three needle insertion of reinforcement (darker part indicate the start / end reinforcement).

Operational details

1、Set input method



* With a linear input program, set from the in situ to the A point of the mobile data, open the "input mode settings screen".

* Press .

* Press .

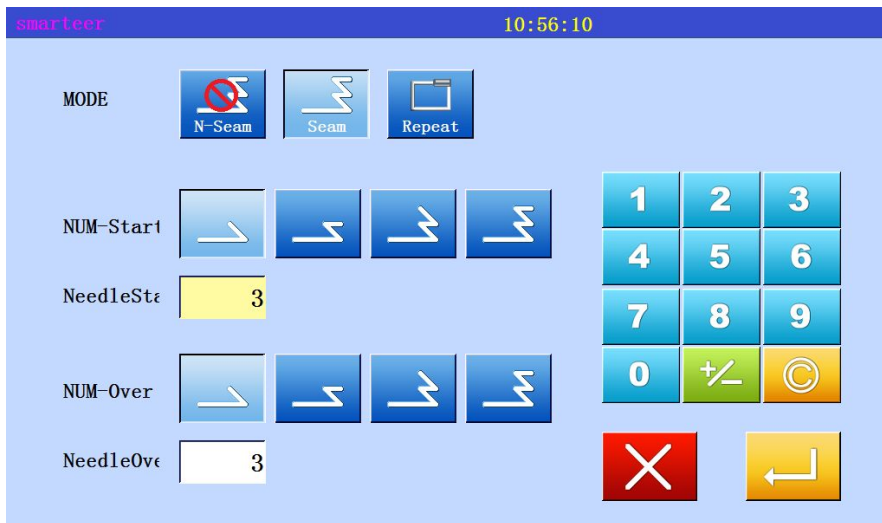

* Press the reinforcement details to set the key .

2、 Set sewing Reinforcement Details



* Set details on this screen.

(The details here are,  倒针)
(Start / end reinforcement),

The first mode  (N mode), The first segment of the three pin, the tail section of the model  (N mode)

* Press , determine the value of these settings.。

* The system will return the arrow input screen".

* Press , determine the set value.

* The system will return to the arrow input screen".

* Linear input process to determine the B point, the establishment of a straight line,

3、 Validation data

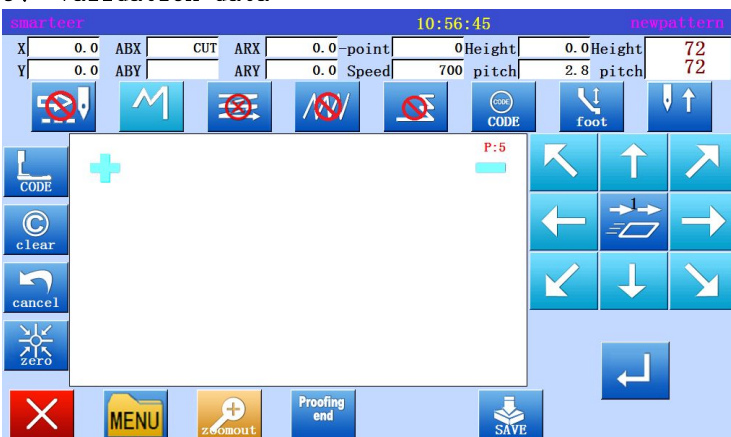

 V mode: 1 times reinforcement

 N mode: 2 times reinforcement

 M mode: 3 times reinforcement

 W mode: 4 times reinforcement

* Has established a line start / end reinforcement data.。

(9) Reinforcement (overlapping reinforcement)

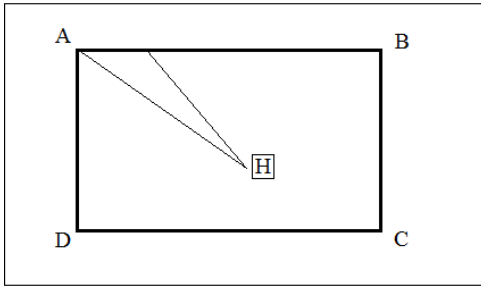

Operational details

1、 Set input mode

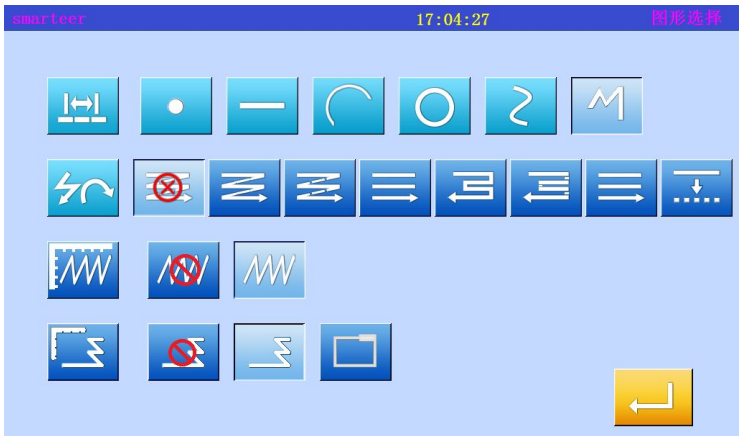

2、 Set Reinforcement Details

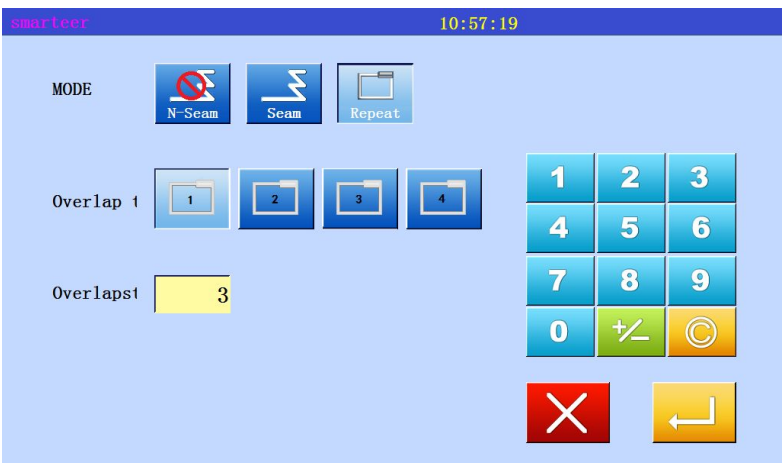

Enter a rectangular polygon, and then insert the overlap reinforcement at the end. (overlapping mode to enter only once for three sewing needle overlap (black) overlap sewing part)

* With the polygon input procedures, set the transfer data from the original point to the A point, open the input mode to set the screen"

* Press polygon input .

* Press "overlapping reinforcement"



* Press the reinforcement details to



set the key

* After the details of the input,



press, set the data.

* Set details on this screen 

(Overlapping reinforcement,

Overlapping mode , 3 stitch sewing).

* Press  OK.

* The system will return to the arrow input screen".

* B, C, D and A points are determined by polygon program, and polygon data is established.

3、 Validation data

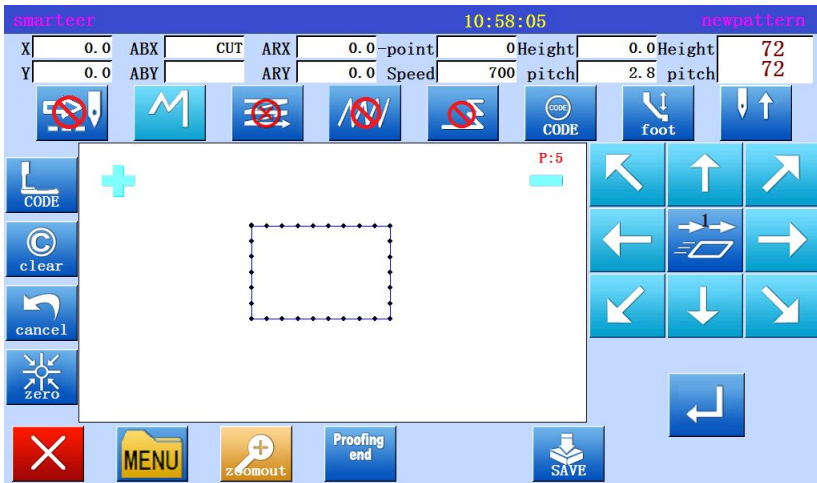

* The rectangle formed by the polygon will be built to reinforce the overlapping seam end.





Memo Overlapping mode

Overlapping patterns of  indicate overlapping portions of the number.

Memo Number of overlapping sewing

This is the number of overlapping parts of the sewing. (set a value between 0-9)

(10) Multiple seam

Type	Connection mode	Key	Notes
Multiple	Move		Sewing threads are not connected
	Sewing		The sewing thread is connected with each other.
Back and forth multiple	Move		Sewing threads are not connected
	Sewing		The sewing thread is connected with each other.

[example] will establish the following types of patterns.

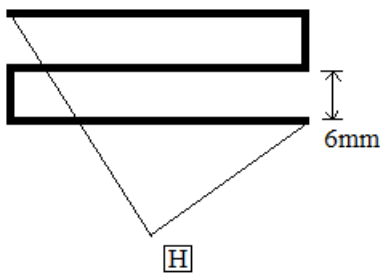

The establishment of linear inverse multiple sewing data.

Operational details

1、 Set input mode

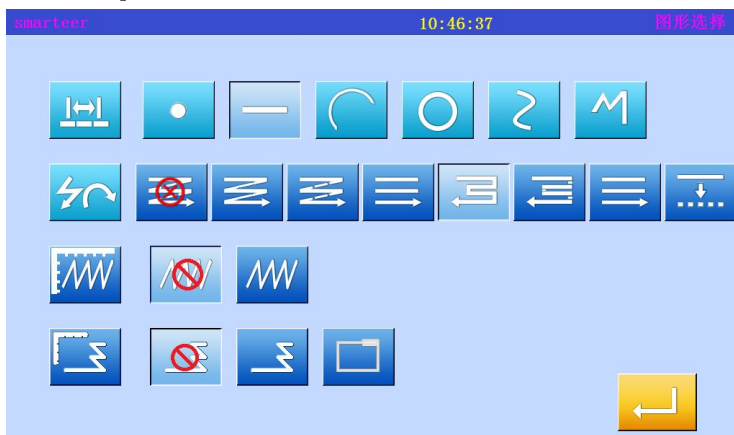

* With the linear input program to set the transfer data from the original point to the A point, open the input mode to set the screen".

* Press .



* Press .

* Multiple seam details, press

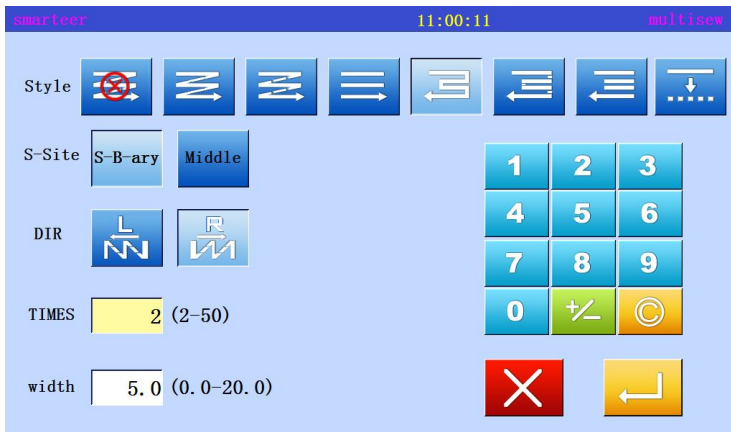

2、 Set back multiple seam details



* Press  and , set the distance of 6.0, the number of times 3

* Press  to set data.

* System will return the input mode settings screen.

* Press , determine the set value.

* The system will return to the arrow input screen.

* Linear input process to determine the B point, the establishment of a straight line.

3、 Validation data

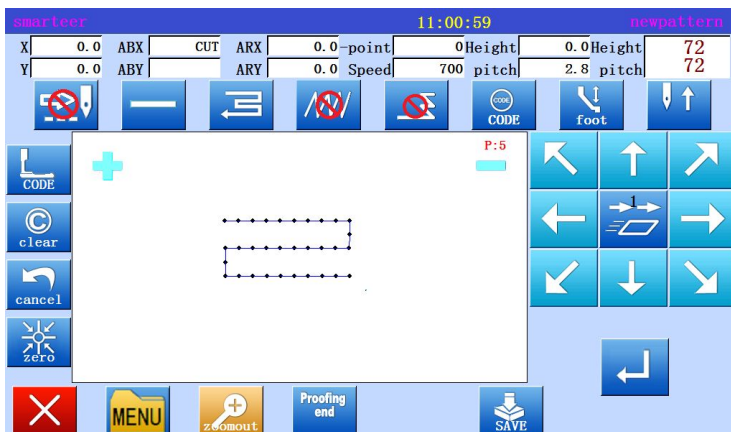

* Linear inverse multiple data has been established.

Memo Direction

When setting up multiple sewing to the left of the input sewing thread, press the 

When setting up multiple sewing to the right of the input sewing thread, press the

Memo

Distance

This is the distance between the multiple sewing and the adjacent lines. Between 0.0mm-20.0mm. Enter the distance data, press the "distance" key to the reverse key. After that, use the numeric keys or the top / bottom arrows to enter the data.

Memo

Frequency

Set the number of layers of sewing. Between 2-9. Enter the number of times, press the "number" key to the reverse key. After that, use the numeric keys or the up / down arrow

keys to enter the data.

(11) Offset sewing

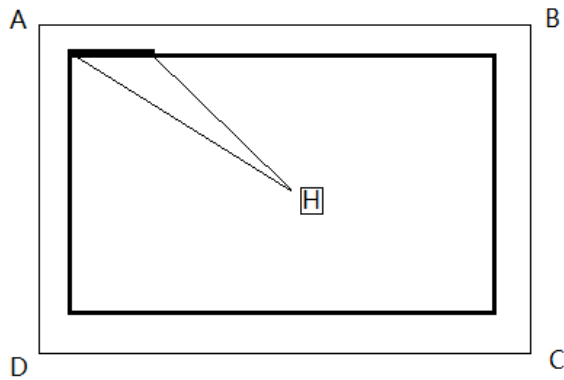

In a polygon mode, input offset sewing (with overlapping reinforcement), set the offset distance: 5.0mm, direction: right, overlapping seam end reinforcement mode: 1, the number of times: 3)

(the dark part of said overlapped reinforcement part)

Operational details

1、 Set input mode

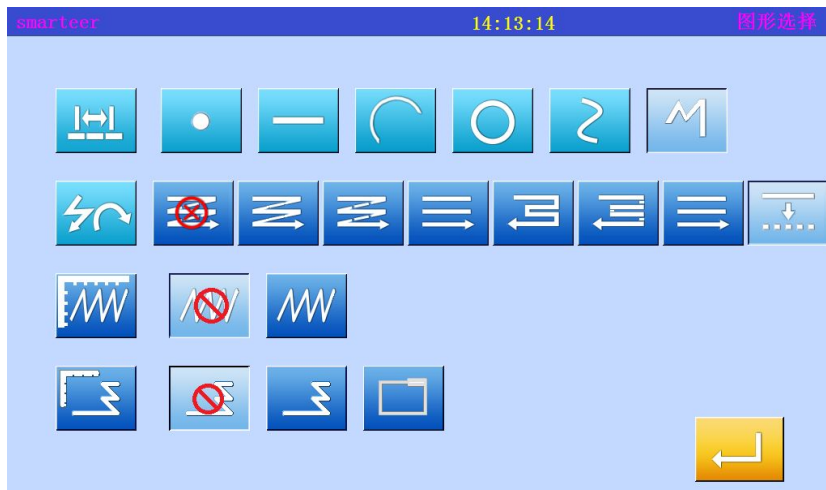

* Using the polygon input program to set the transfer data from the in situ H to A point, open the "input mode setting screen".

* Press

* Press offset input

* Press

* Press

2、 Set migration details





* Press , set distance: 5

* The number of offset can be set to 0.1mm to 0-20mm increments.



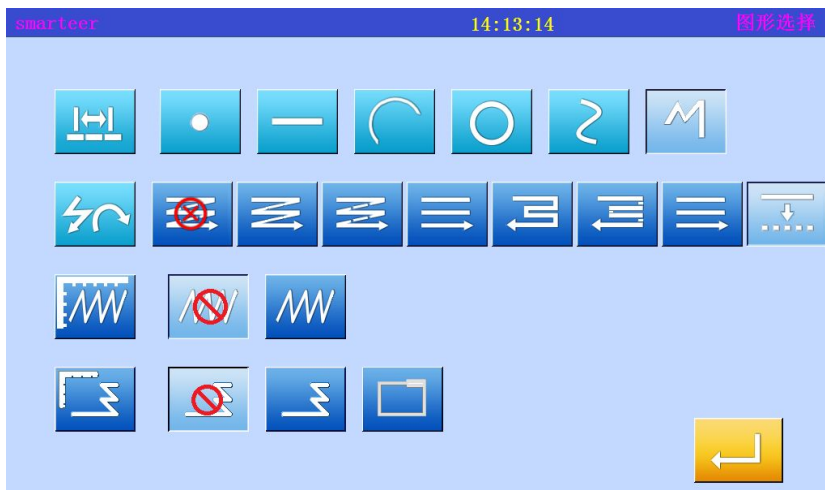

* Press to set data.

3、 Set Reinforcement Details



* After returning the "input mode settings screen", press the reinforcement details to set the key. .



*  (Overlapping reinforcement), Overlapping mode , Three overlapping sewing)
 * After inputting the details, Press  to set data.
 * The system will return to the input mode to set the screen.
 * Press  to determine the set value.。

* B, C, D and A points are determined by polygon program, and polygon data is established.

4、 Validation data

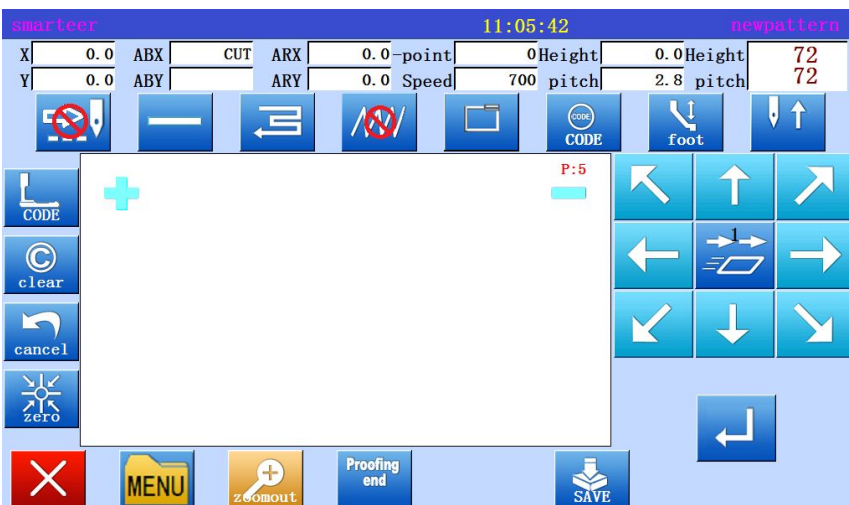

*。 Display offset data on the image screen.

(12) Zigzag stitching (with overlapping reinforcement)

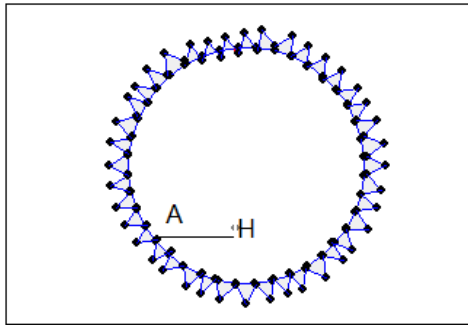

Operational details

1、 Set input mode

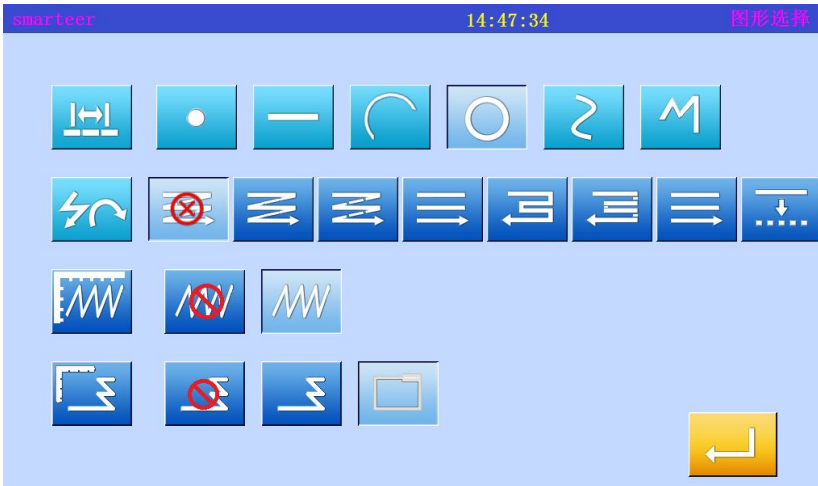

2、 Set zigzagsewing details.

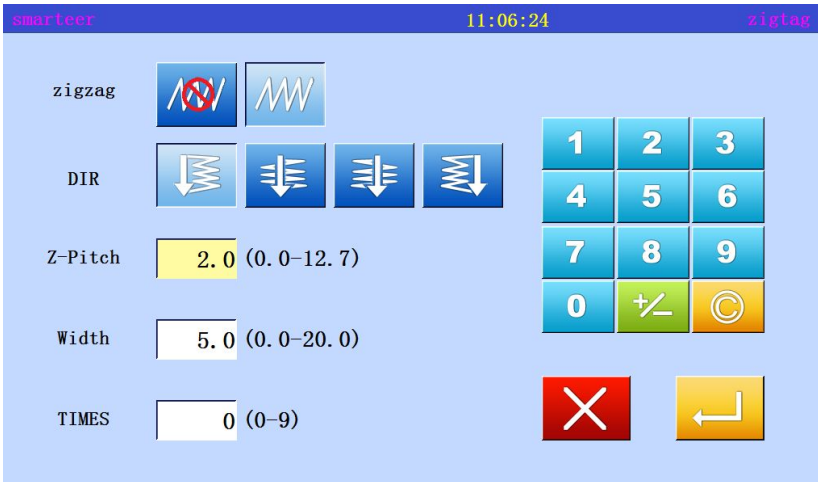

Input with overlapping suture reinforcement end lambdoid suture, the circle. The offset width of the figure is 5.0mm, the transfer amount is 3.0mm, the direction is left, and the implementation of an overlapping reinforcement, to carry out the three stitch overlapping sewing. (black overlaps the reinforce part)

* With the polygon input process, set from the H to the A point of the cloth to send data, open the "input mode settings screen".

* Press  .

* Press  .

* Press  .

* Set zigzagsewing details.

* Press  .

* Press  the set offset width 5.0, send the number of 3.

* Zigzagsewing distance can increase by 0.1mm in 0.5-10mm.

* Press  to set data.

Offset width, the number of send cloth and the direction of establishment

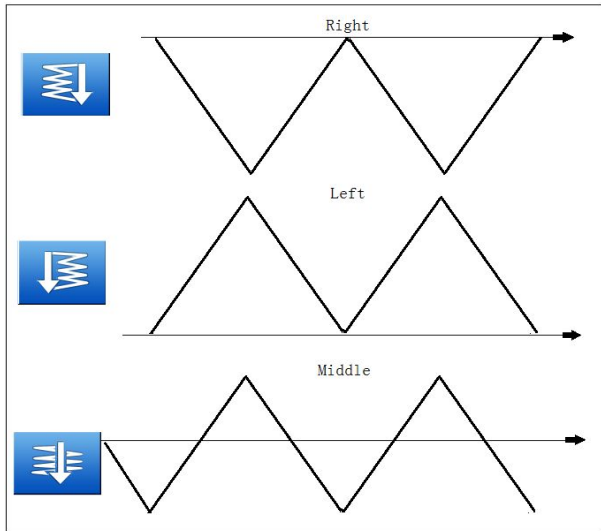
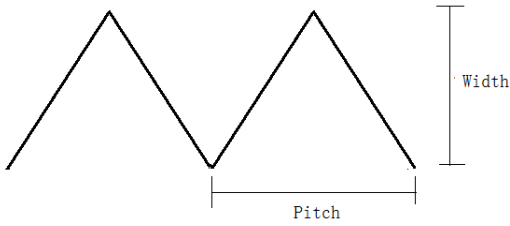



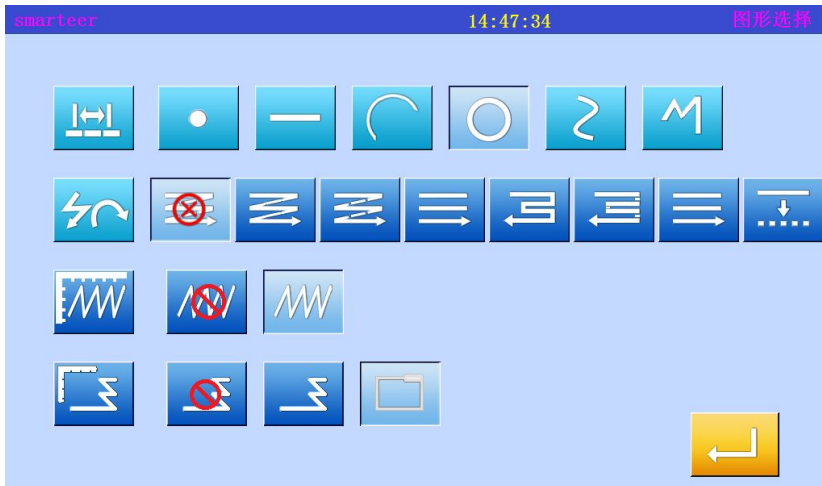

3、 Set Reinforcement Details



* After returning the "input mode settings screen", press the reinforcement details to set the key. .



* , Overlapping mode
 Three stitch sewing)

* Press , set data.
 * The system will return to the input mode to set the screen
 * Press A  key to determine the set value.
 * The system will return to the arrow input screen.
 * When entering the program according to the circle data, determine the B points, C points, the establishment of the circle data.
 * After the circle data is set up, press .

4、 Validation data

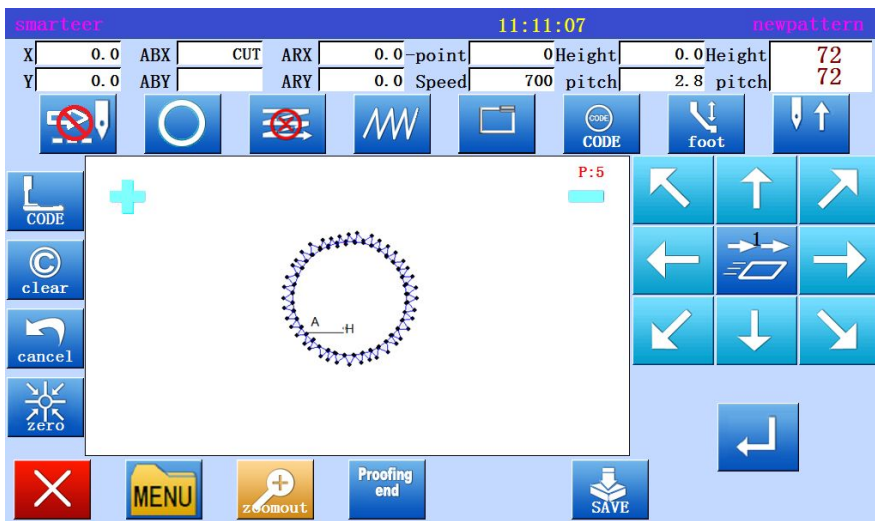

* Zigzagsewing (with overlapping reinforcement)

[2]. Comprehensive sewing type table

Basic input	Application input					
	Multiple lines	Back and forth multiple lines	Line offset	zigzag	Start / end reinforcement	Overlapping reinforcement
straight line						
	○					
		○				
			○			
				○		
					○	
	○			○		
	○				○	
	○			○	○	
		○		○		
		○			○	
		○		○	○	
			○	○		
			○		○	
			○	○	○	
Arc						
	○					
		○				
			○			
				○		
	○				○	
	○			○		
	○				○	
		○		○	○	
		○		○		
		○			○	
			○	○	○	
			○		○	
			○	○	○	
			○	○	○	
circular						
	○					
		○				
			○			
				○		
					○	
	○			○		○
	○				○	
	○					○
	○			○	○	
	○			○		○

Basic input	Application input					
	Multiple lines	Back and forth multiple	Line offset	zigzag	Start / end reinforcement	Overlapping reinforcement
circular		○		○		
		○			○	
		○				○
		○		○	○	
		○		○		○
			○	○		
			○		○	
			○			○
			○	○	○	
			○	○	○	○
				○	○	○
curve	○					
		○				
			○			
				○		
					○	
						○
	○			○		
	○				○	
	○					○
	○			○	○	
	○			○		○
		○		○		
		○			○	
		○				○
		○		○	○	
		○		○		○
			○	○		
			○		○	
			○	○	○	
				○	○	○
polygon						
	○					
		○				
			○			
			○			

Basic input	Application input					
	Multiple lines	Back and forth multiple lines	Line offset	zigzag	Start / end reinforcement	Overlapping reinforcement
polygon					○	
						○
	○			○		
	○				○	
	○			○	○	
	○			○		○
		○		○		
		○			○	
		○				○
		○		○	○	
		○		○		○
				○	○	
				○		○
				○	○	○
				○	○	○
					○	○
					○	○
point	It is not possible to combine the input of the same application. .					

Combined pattern

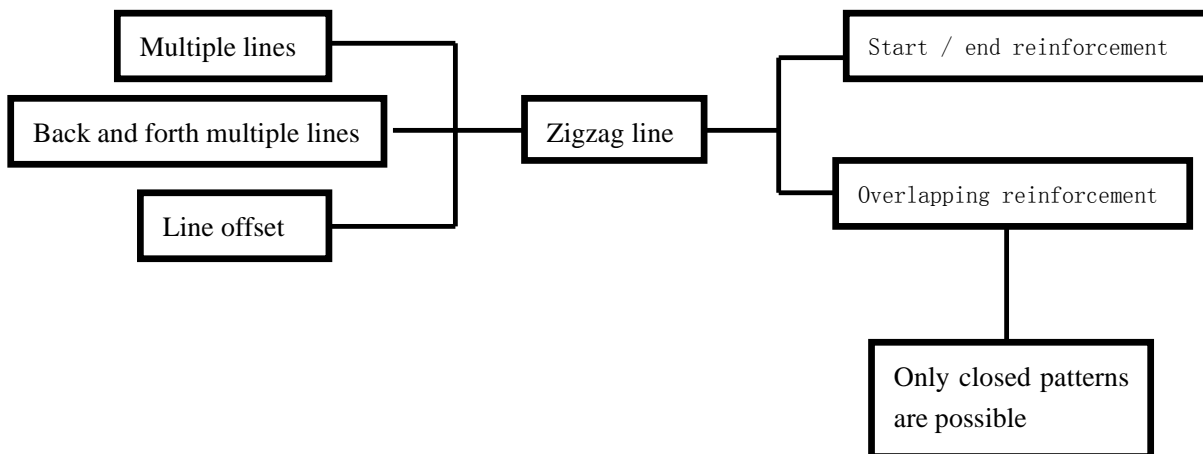

[3]. Call graph function

In the sewing data entry mode, you can extract the data from the memory, and then combine the extracted data with the current data to establish a new sewing data. You can decide to remove the transfer of the needle and the origin of the transfer.

To create the following sewing data, set up the double circle data , then use the send data and extract features.

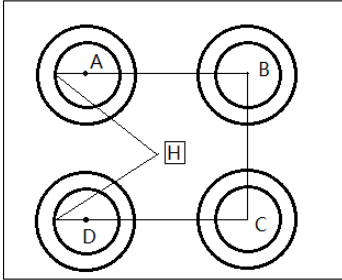

- (1) The establishment of data from the in situ H to A point of the cloth feeding data
- (2) Display extraction function

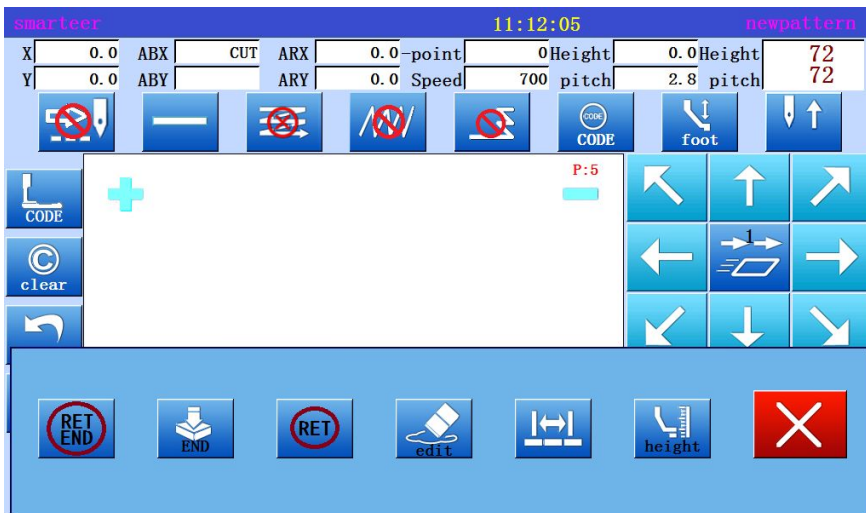

* Press  .
 * Press  .

- (3) Select call data

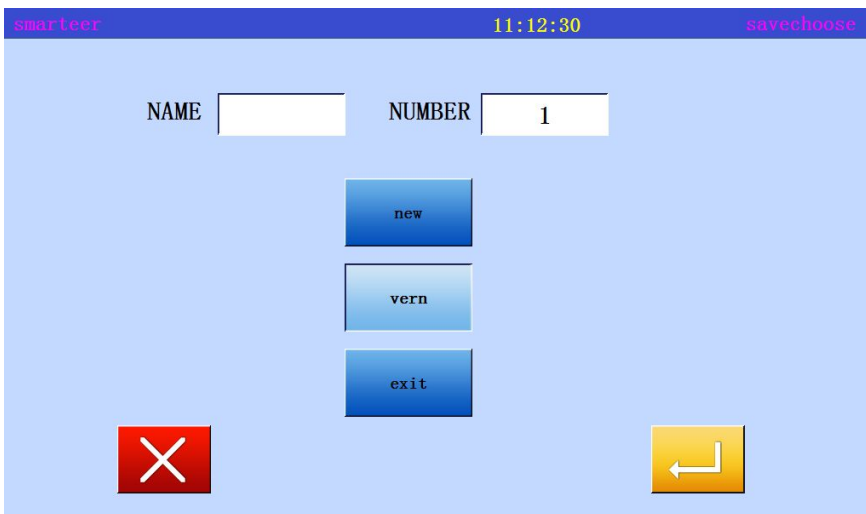





















* Select the data you want to call out, press  .

- (4) As for B, C and D, in the same way call data, complete the data.

[4]. Modify mode





(1) Modify mode function

	Function	Key	Details	Detail setting
Sewing	Moving sewing starting point		Moving sewing starting point	--
	Delete		Delete the specified sewing	 Specified number of sewing  All sewing
	Add needle		Add a sewing data to the specified location	A sewing to add Add the same sewing
	Sewing position modification		Modify sewing position	 fixed  Related movement
	Segment movement		Data in the specified range is removed.	 Change  Add a shot in the middle
	Segment modification		The region of the two points to be modified by a straight line, a line, an arc, a curve, a person's figure, or a feeding data.	--
	Pitch modification		Modify the needle distance in the specified range.	 A few stitches after the specified position  All after the specified location
Speed 	--	Modify speed from specified sewing	 A few stitches after the specified position  All after the specified location	
Code 	--	Add or remove code data from the specified sewing position	 Add  Delete	

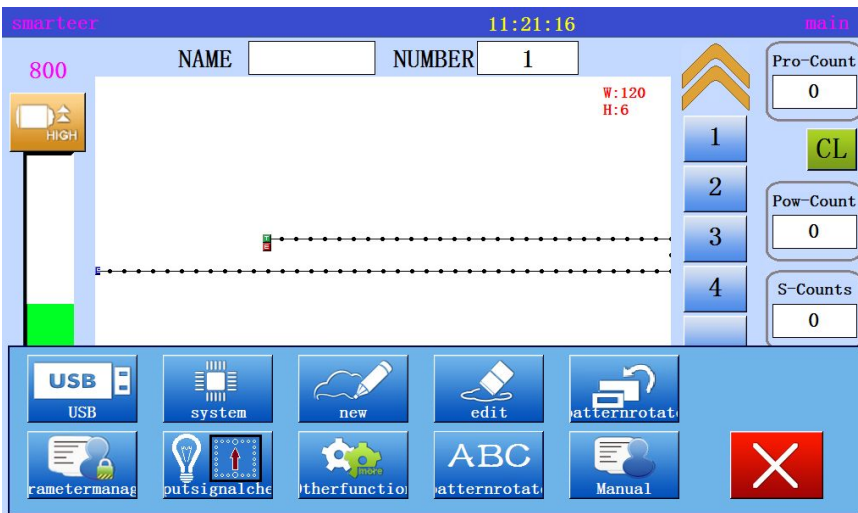
Enter modify mode

Using standard screen method



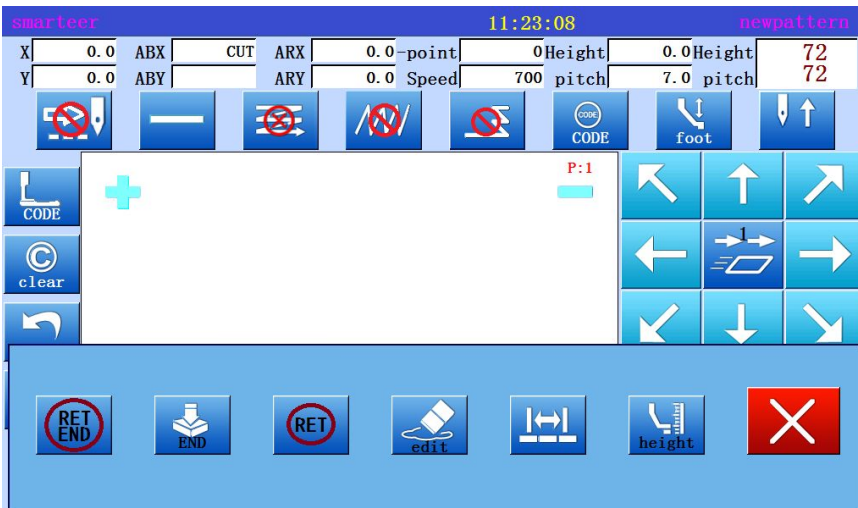

* Press  and  (on the standard screen) to modify the mode. Or, press  and  enter modify mode in the input mode.



(2) Exit modification mode



* After making the changes, press  the exit modification mode. (when you press , the final execution of the changes will be cancelled.)

(3) Change to in situ transfer data

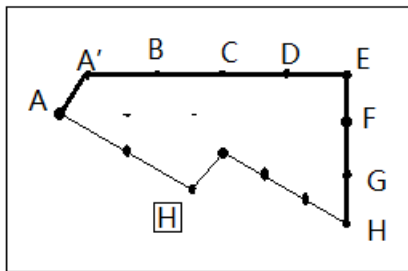
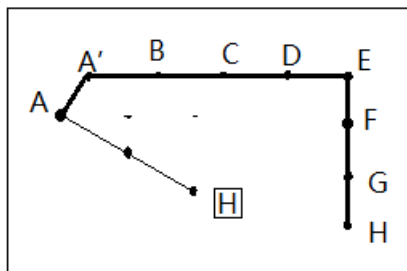
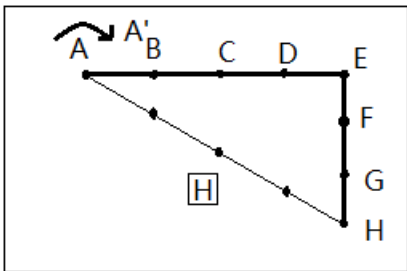
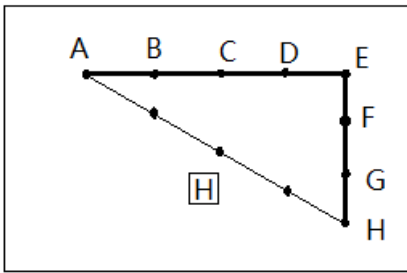

As shown on the left, this section to explain is to add a sewing data on the original and add A example.

Add A points as shown in Figure

When adding A points, B points to the location of the H point will be changed, therefore, from the point of H to the in situ feeding data will also change, can be selected in the following keys to change the feeding data method. .

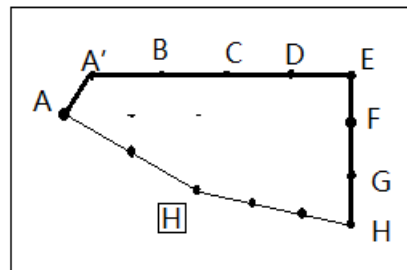

(4) Modify sewing starting position

[example] as shown below, the starting point of the sewing A points will be modified to B

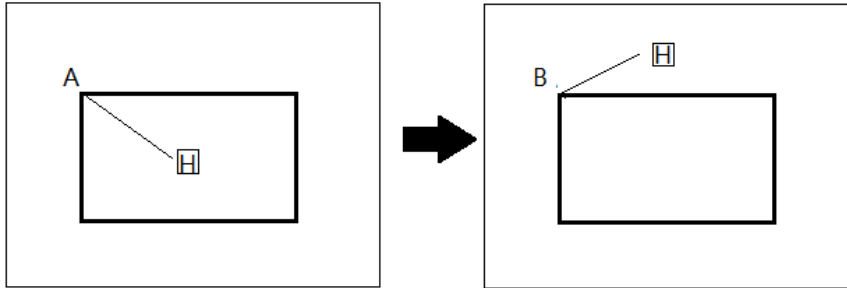

Operational details

1. Select sewing starting position

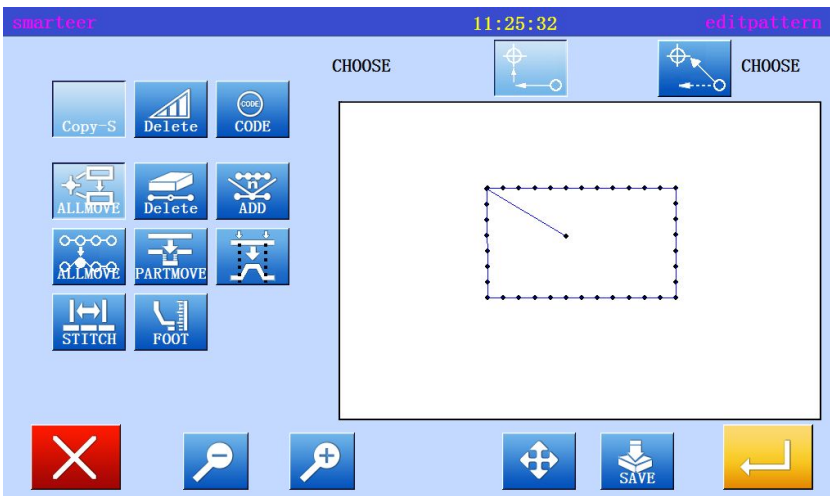

* Enter modify mode

* Press  and press



* Press  key to set data.

2. Move to modify position, set data

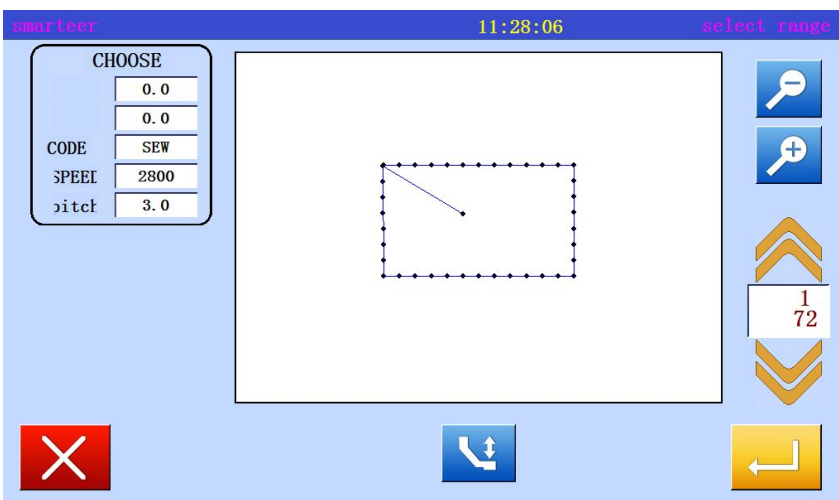

* Press the arrow keys to move the position to the B point.

* Press .

* If pressed , the screen will return to the previous screen.

3. Confirm modified data

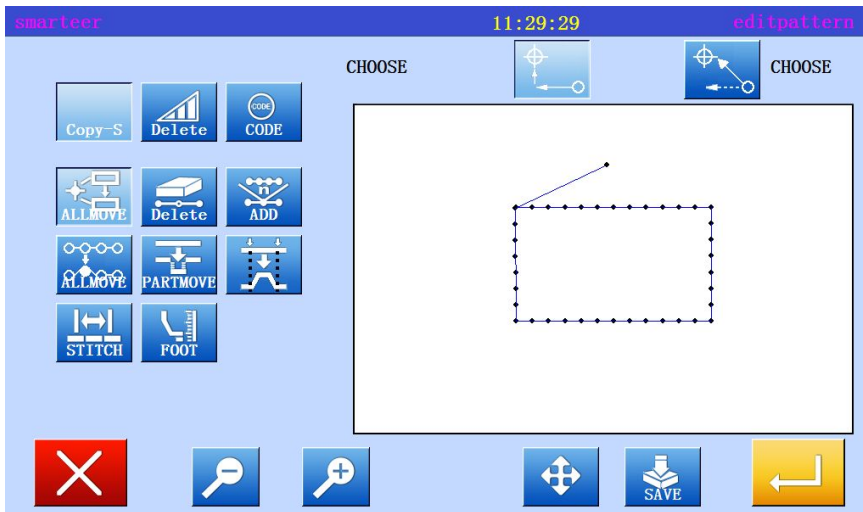

* Exit modification mode.

Press  return to standard screen.

4. Confirm with standard screen

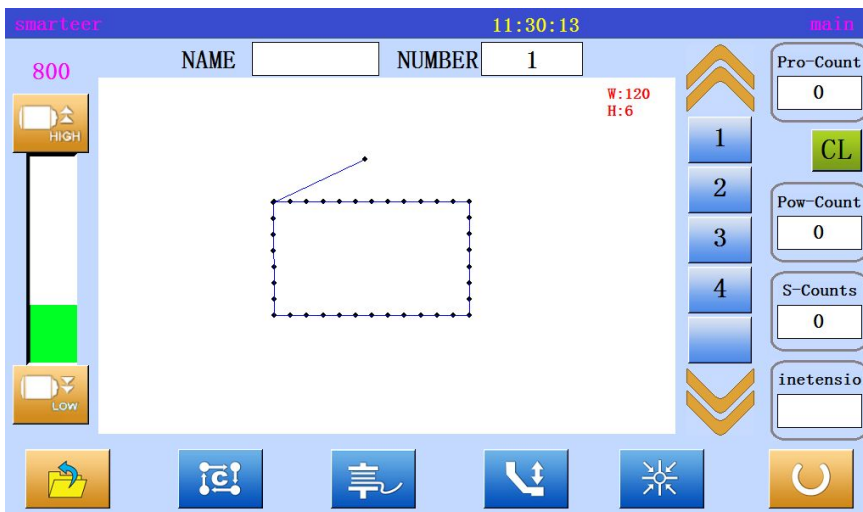

* Sewing start position has been modified

Memo

The use of "modify the needle position" to modify the information contained in the automatic inverted needle, the characteristics are as follows:

Note: when using the B type and the BA type, the operation is respectively

The following figure is a single line V - shaped inverted needle that contains the head and tail sections. (inverted needle position represented by thick black line)

At this time the sewing sequence for the A to B to C to D, the actual starting position is A

(Note: the starting point for the B)



[BA type information] when entering "modify the needle position" directory, stitch the opportunity to automatically to the A point. (move to the actual starting point A).

[B type information] when entering the "modify the needle position" directory, the opportunity to automatically move to B points. (move to the actual starting point B)

(5) Delete a stitch (delete the specified pin count)

[example] the sewing patterns between the C and D points are removed in the following sewing data.

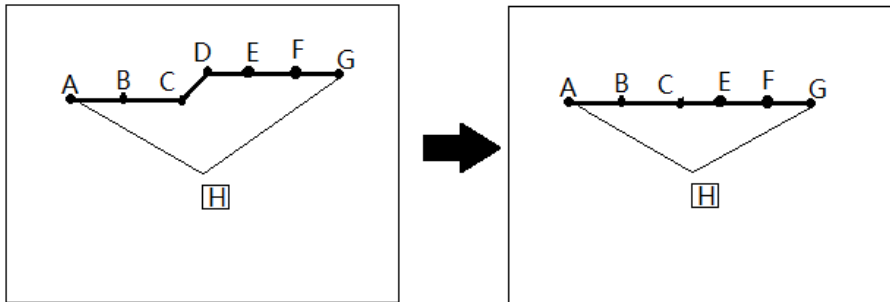

Operational details

1、 Select Delete sewing

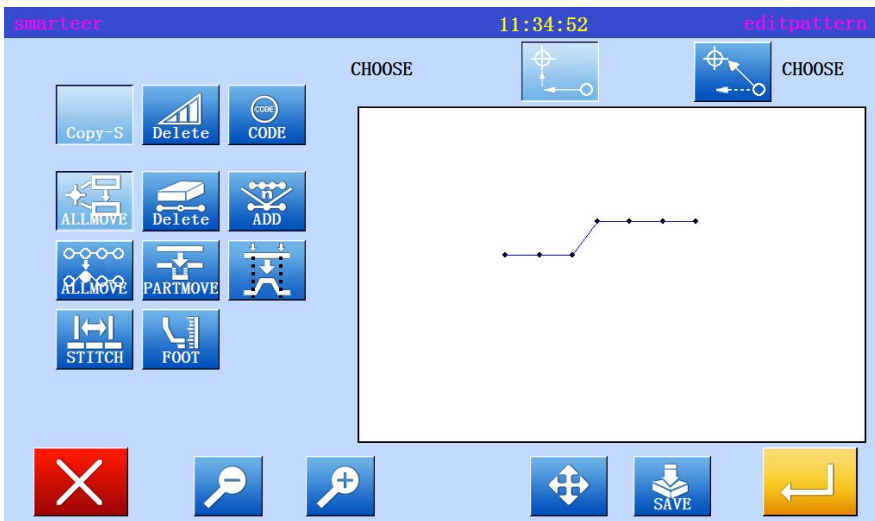

* Enter modify mode

* Press  and .

* Press  to open the next screen.

2、 Decided to delete the location

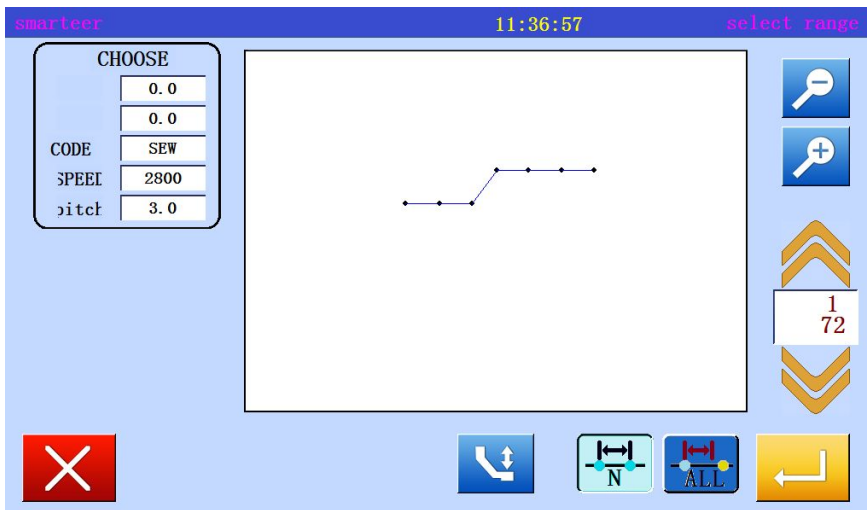

* With a slow key , the decision to delete the location.

* Set to the sewing position (C point), just before the location to be deleted.

* Set position, press. .

3. Setting delete method

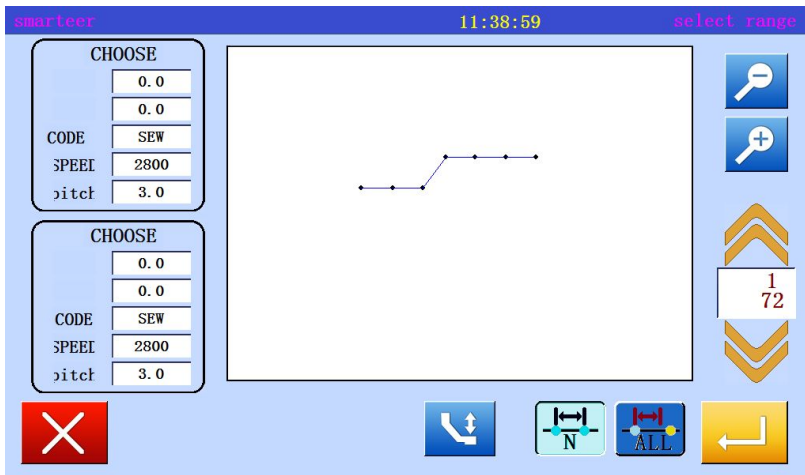

* Press .

* Set the number of needles to remove to 1, and then Press



.

4. Confirmation after sewing

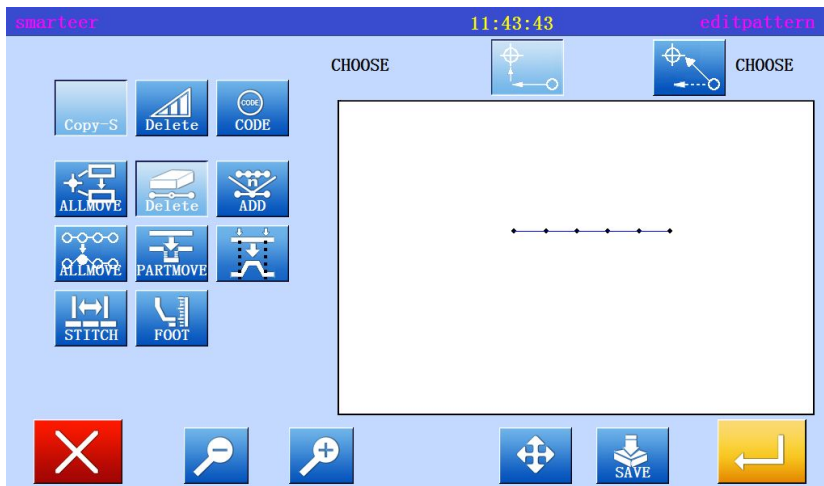

* Exit modification mode.

Press  to return to the standard screen.

5. Confirm with standard screen

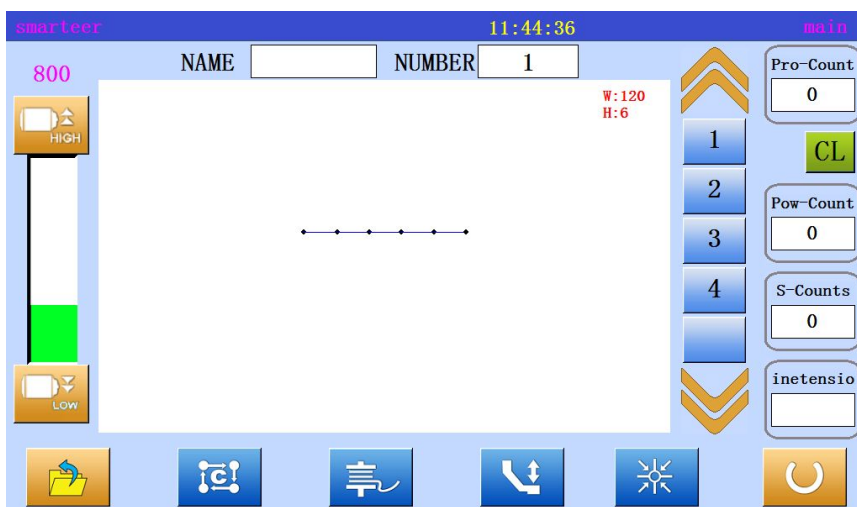

* Stitch has been deleted.

(6) Delete a stitch (delete the specified location after all stitching)

[example] the following sewing data, E points after the sewing pattern will be deleted.

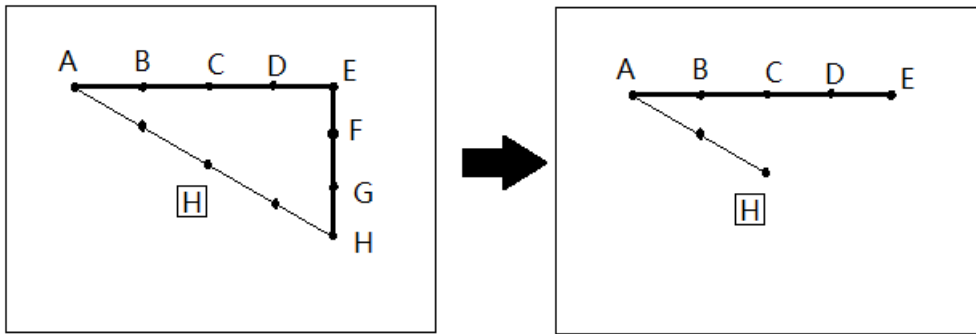

Operational details

1、 Select Delete sewing

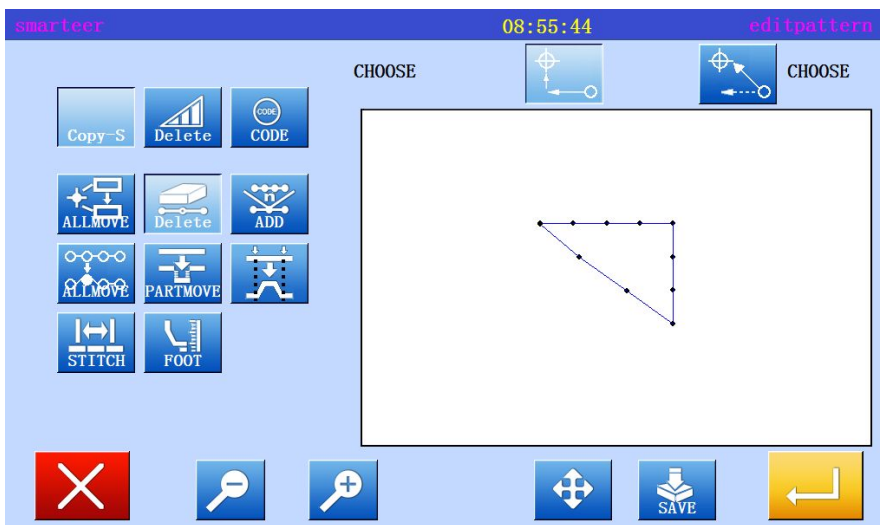

* Enter modify mode

* Press  and .

* Press  to open the next screen.

2、 Decided to delete the location

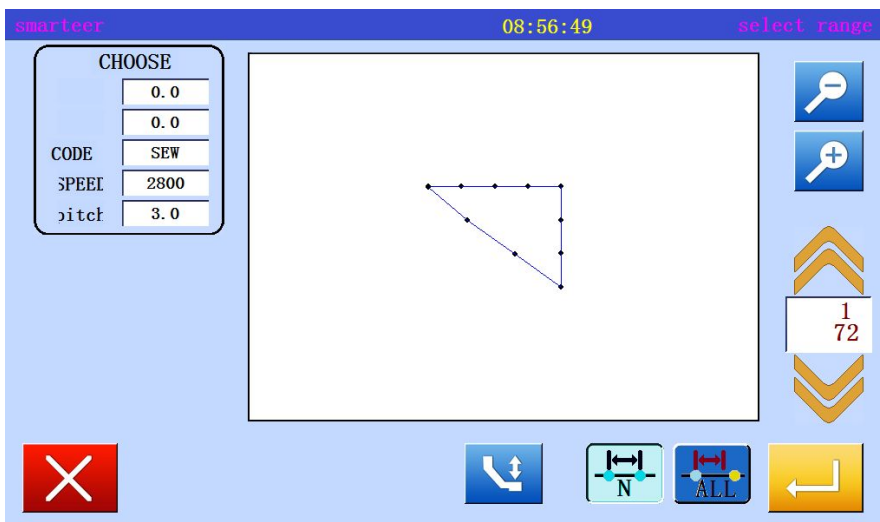

* With a slow key  , the decision to delete the location.

* Set to the sewing position (C point), just before the location to be deleted.

* Set position, press. 

3. Setting delete method

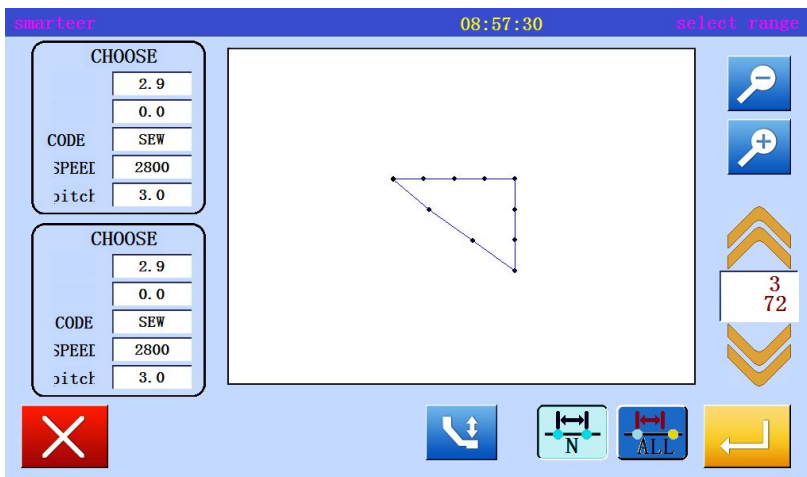

* Press .

* Set the number of needles to remove to 1, and then Press



4. Confirmation after sewing

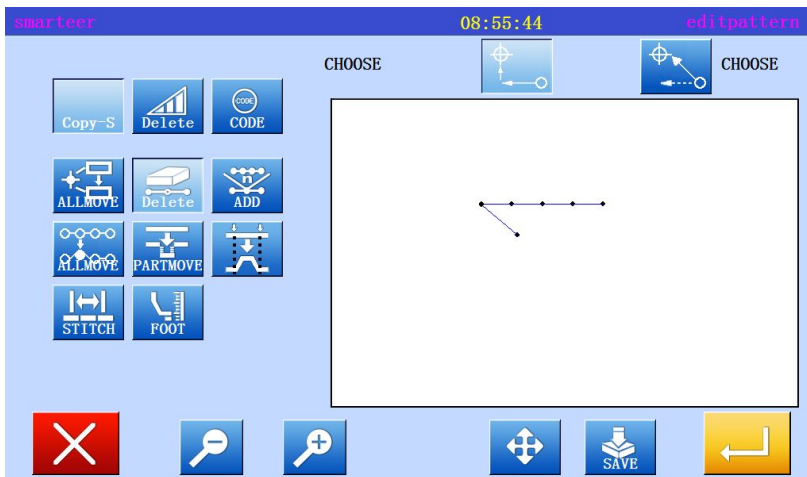

* Exit modification mode.

Press  to return to the standard screen.

5. Confirm with standard screen

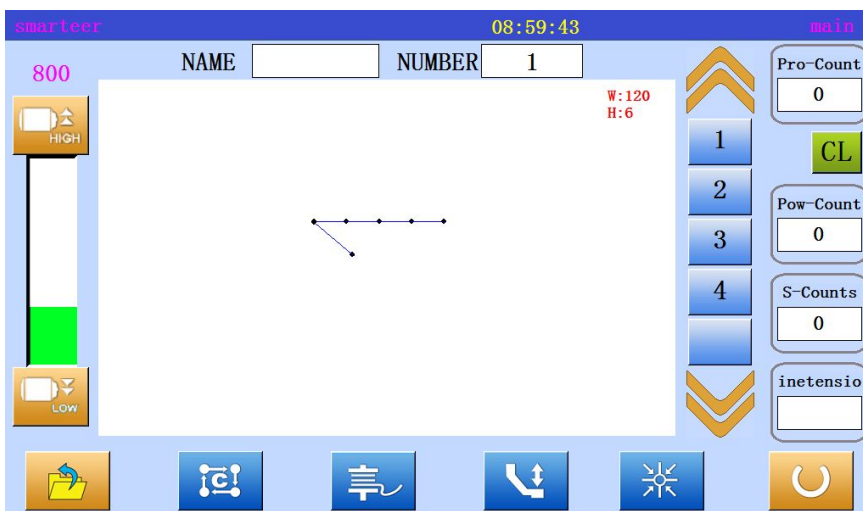

* Stitch has been deleted.

(7) Add a stitch (add a sewing)

[example] in the following types of sewing data, the required length A' is added to the A (maximum line length 12.7mm (A and A')

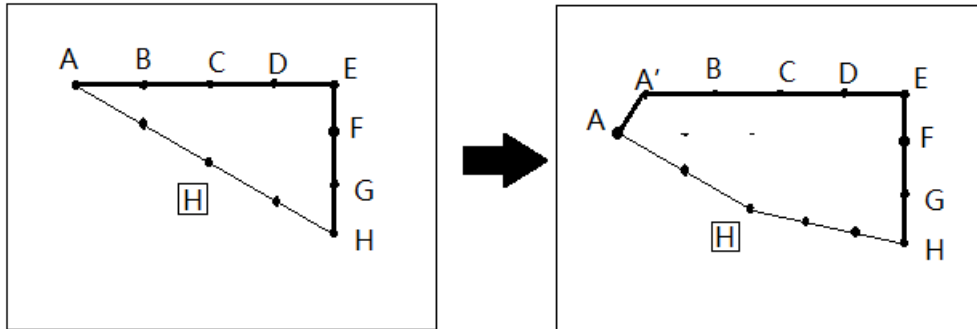

Operational details

1、 Choose to add a needle

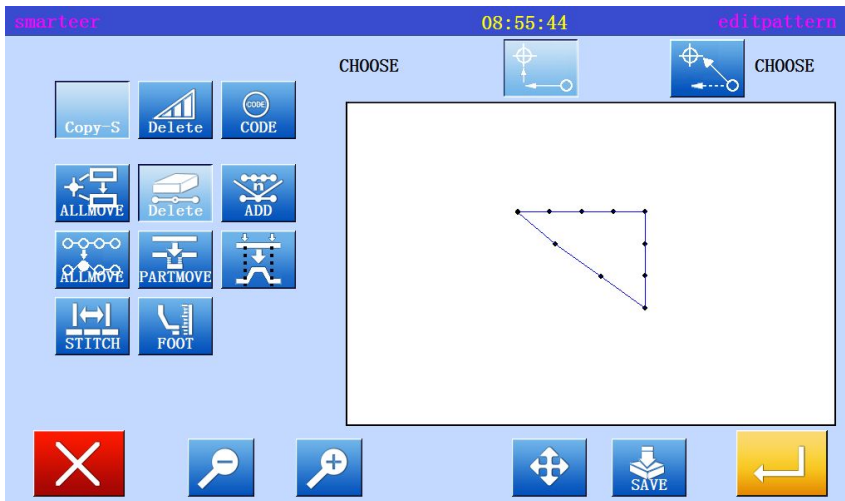



* Enter modify mode

* Press  and .

* Press , open the next screen.

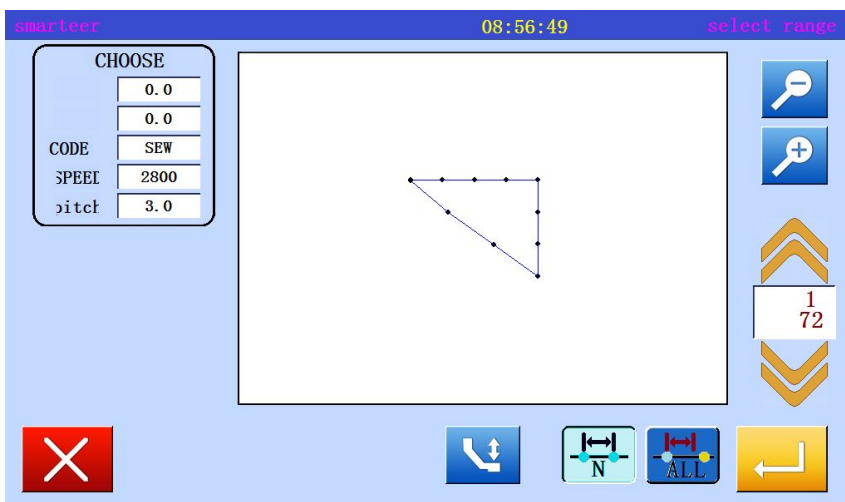
2、 Decide to add location





* With  the decision to add the location, move to the add position (A point).

* Press .

3、 Set add method



* With the arrow keys to move and enter to add the sewing position, press 

* Enter the number of add pin, press 

4、 Confirmation after sewing

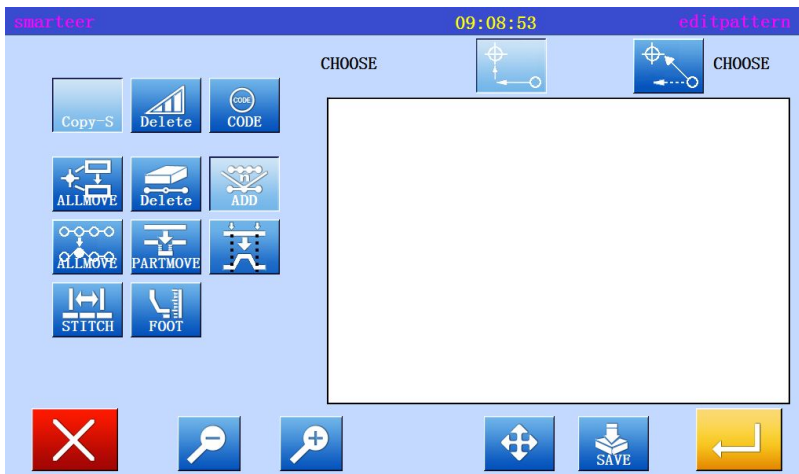

* Exit modification mode.

Press  to return to the standard screen.

5、 Confirm with standard screen

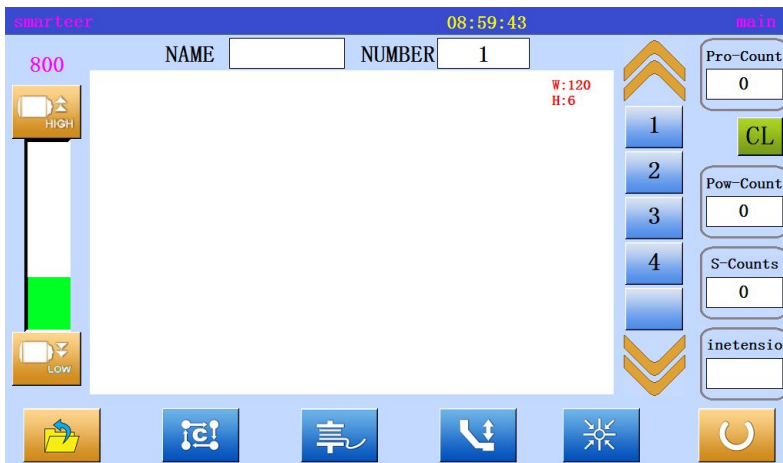

* A needle has been added

(8) Add a stitch(Add the same sewing)

[example] in the following types of sewing data, the same as the A point of the sewing A 'will be added to the A point

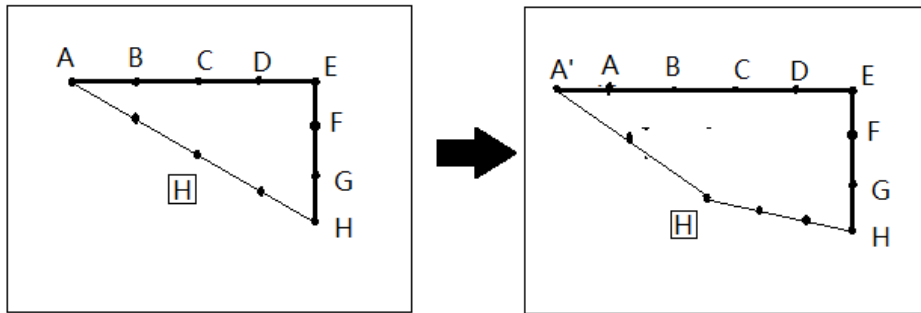

Operational details

1、 Choose to add a needle

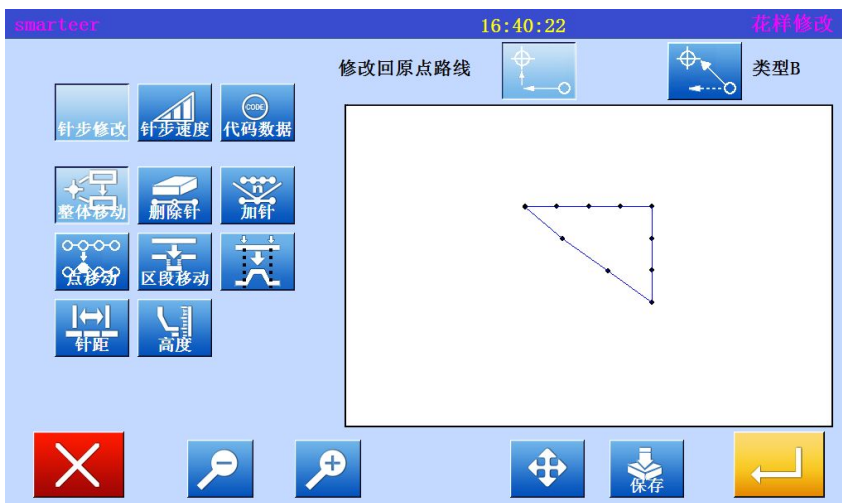



* Enter modify mode

* Press  and .

* Press , open the next screen.

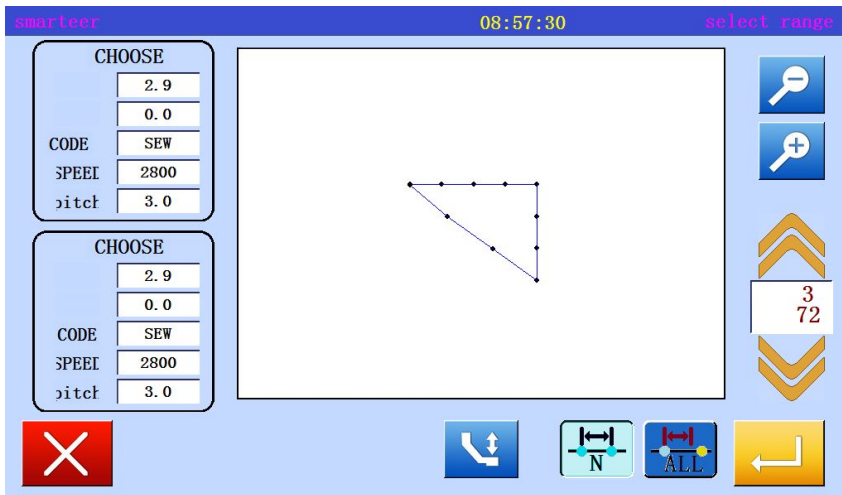
2、 Decide to add location





* With  the decision to add the location, move to the add position (A point).

* Press 

3、 Set add method



* With the arrow keys to move and enter to add the sewing position, press 

* Enter the number of add pin, press 

4、 Confirmation after sewing

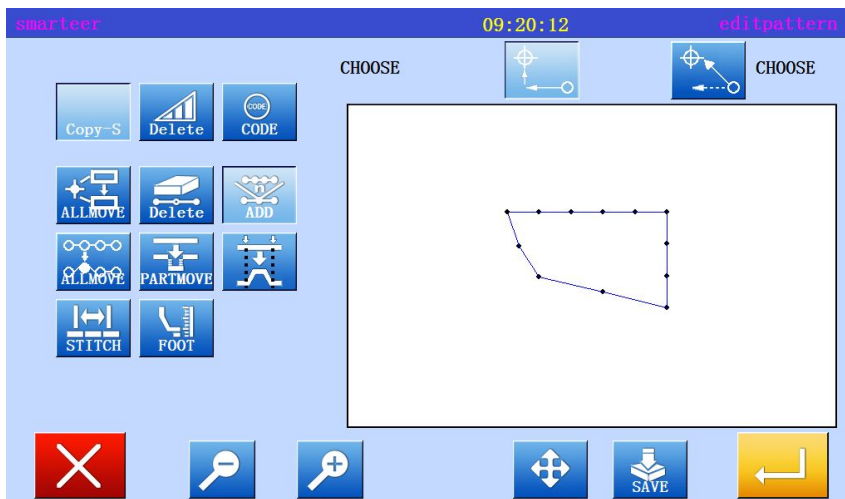

* Exit modification mode.

Press  to return to the standard screen.

5、 Confirm with standard screen

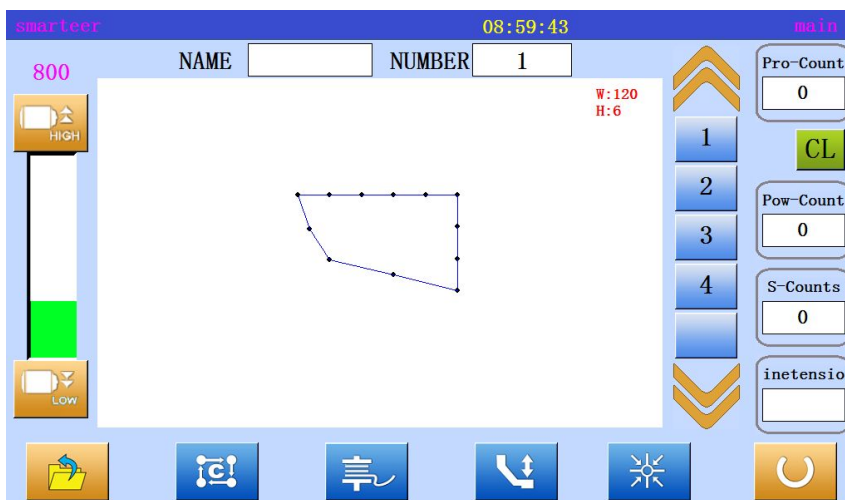

* A needle has been added

(9) Modify the sewing position (after the data is connected to the fixed position)

[example] in the following types of sewing data, the same as the A point of the sewing A' will be added to the A point

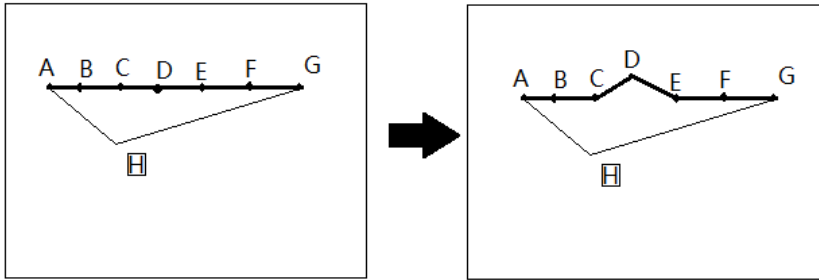

Operational details

1、 Choose to add a needle

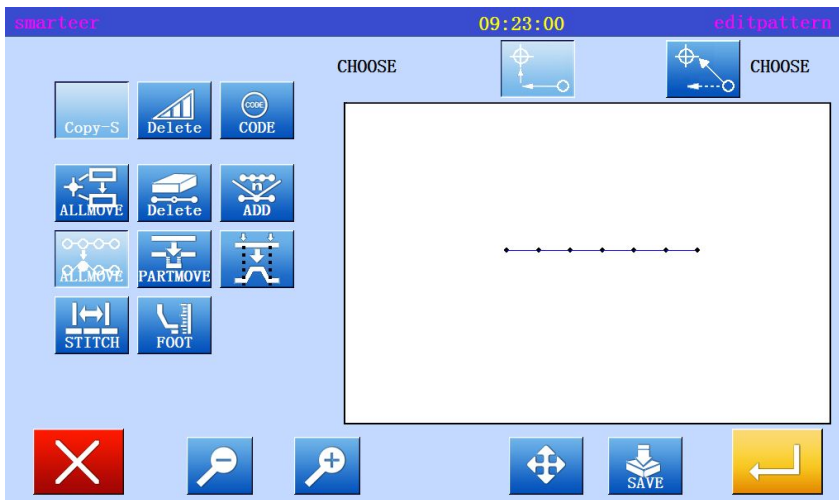



* Enter modify mode

* Press  and .

* Press , open the next screen.

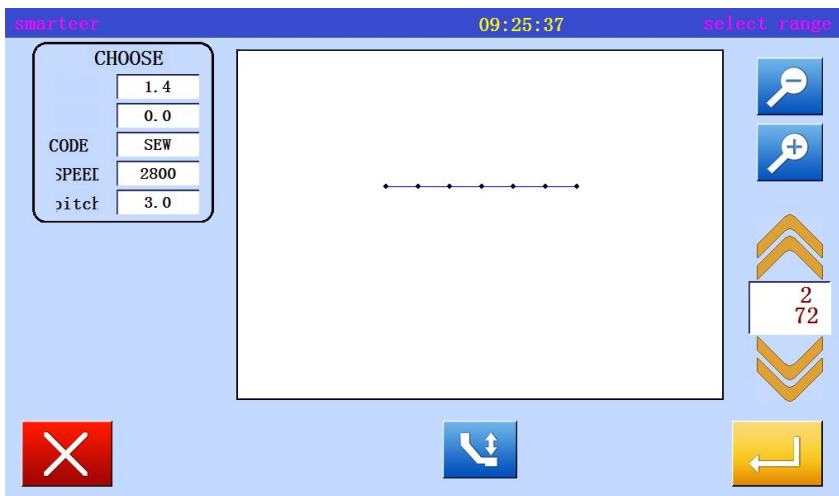
2、 Decide to add location



* With  the decision to add the location, move to the add position (D point).

* Press 

o

3、 Set the number of changes and modifications

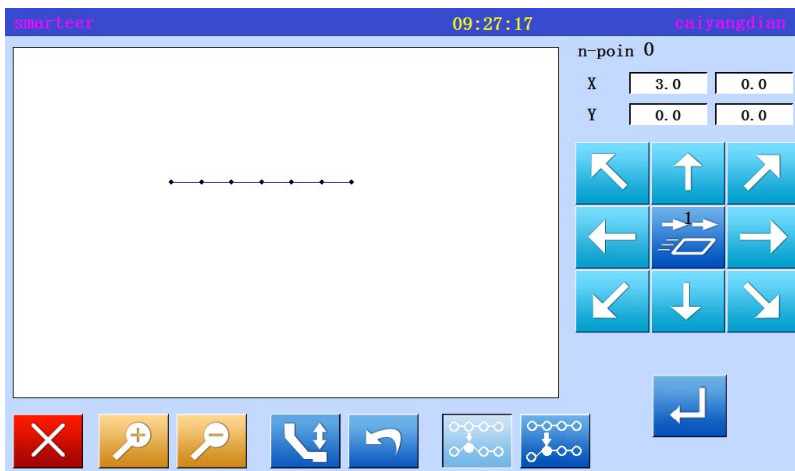

* To set the way to modify, press (modify the pattern of sewing data unchanged). Move to the modified position (D '), using the arrow keys.

* Press .

4、 Confirmation after sewing

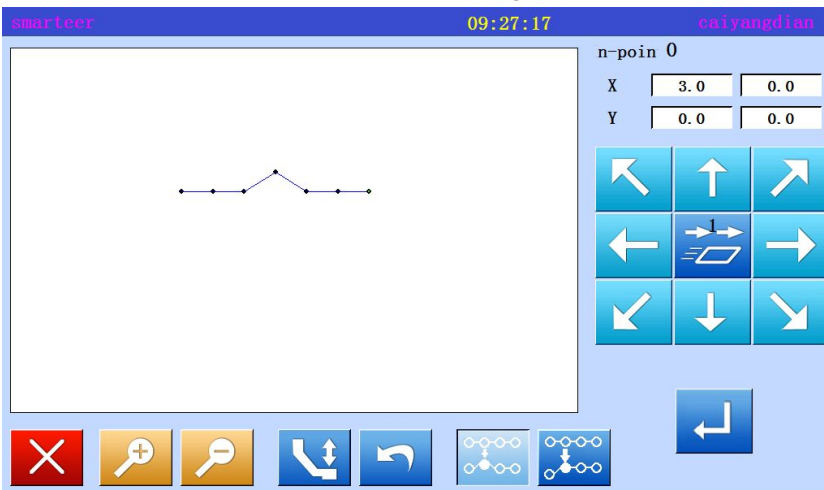

* Exit modification mode.

Press  to return to the standard screen.

5、 Confirm with standard screen

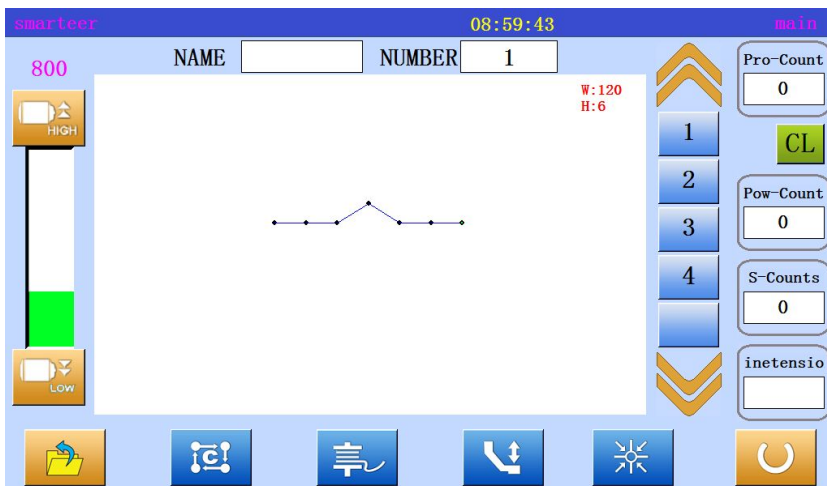

* A needle has been added

(10) Modify the sewing position (after the data position is connected to the mobile)
 [example] in the following types of sewing data, the C will be moved. (D, E, F and G mobile)

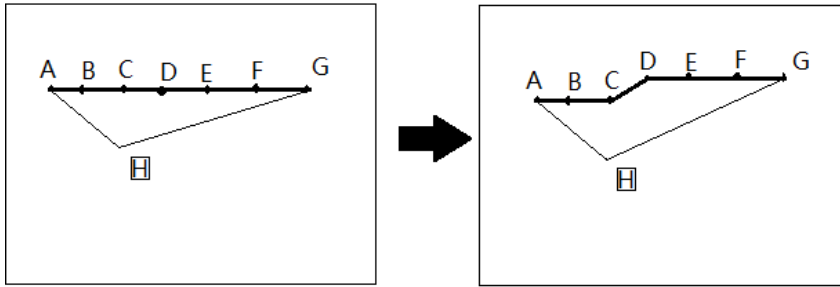

Operational details

1、 Choose sewing position modification

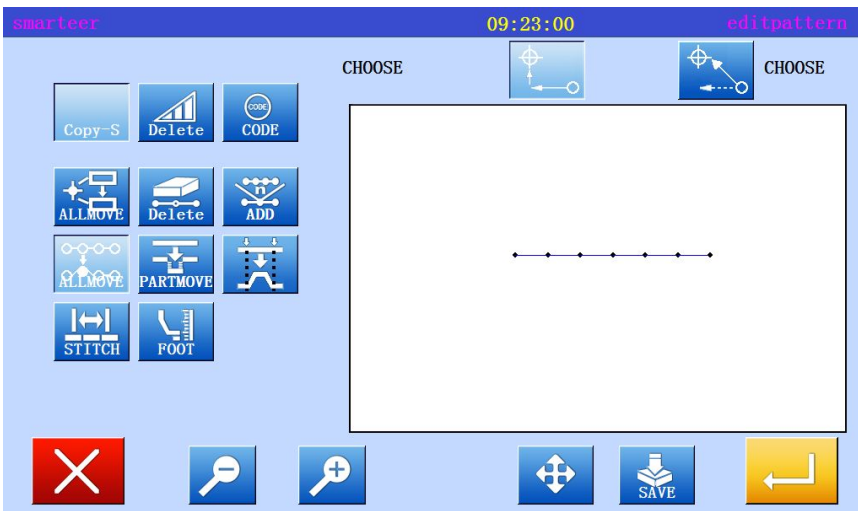



* Enter modify mode.

* Press  and  .

* Press , open the next screen.

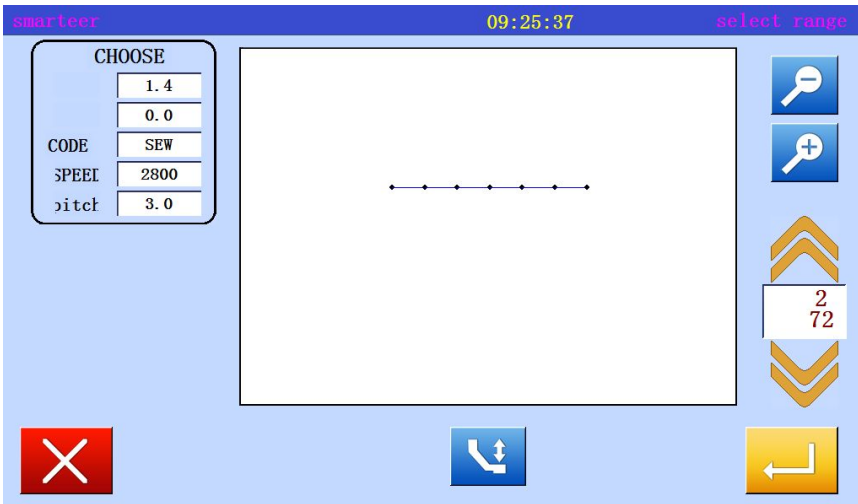
2、 Decide to add location



* With  the decision to add the location, move to the add position (C point).

* Press 

3、 Set the number of changes and modifications

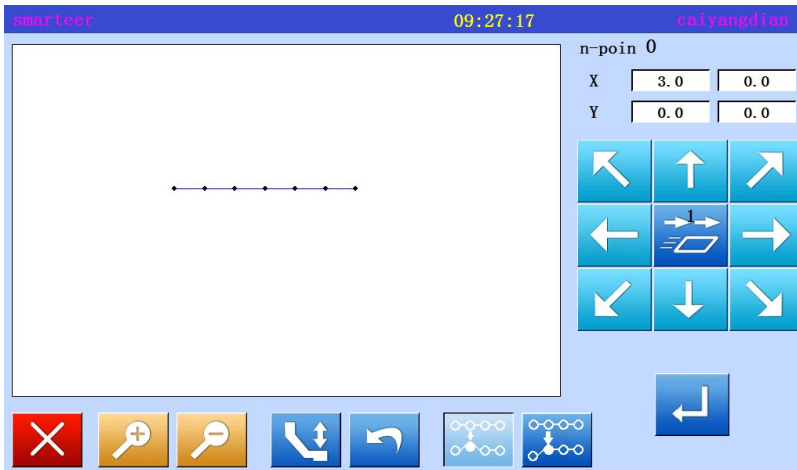

* To set the way to modify,



press (modify the pattern of sewing data unchanged). Move to the modified position (C'), using the arrow keys.



* Press

4、 Confirmation after modification

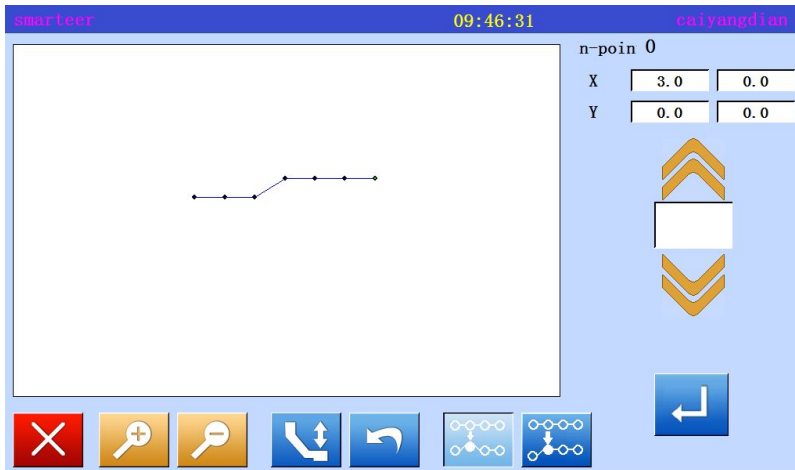

* Exit modification mode.



Press to return to the standard screen.

5、 Confirm with standard screen

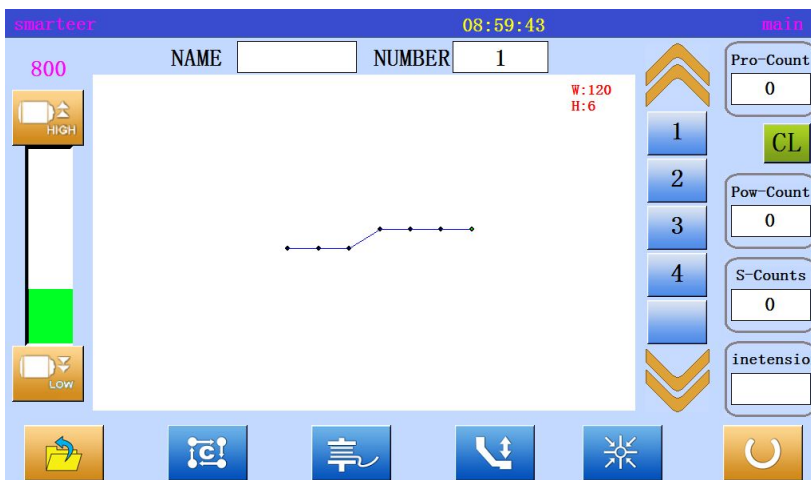

* Needle position has been modified.

(11) Modify a paragraph (change the front / back data)

[example] in the following types of sewing, the D point and the E point between the parts will be moved to the D' point and E' point. At this point, the front or back data between the E' and D' points will be changed.

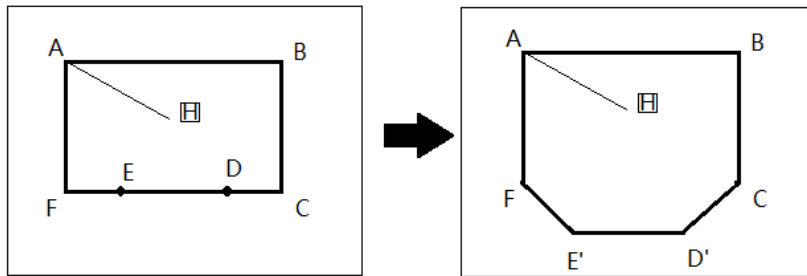

Operational details

1、 Select segment move

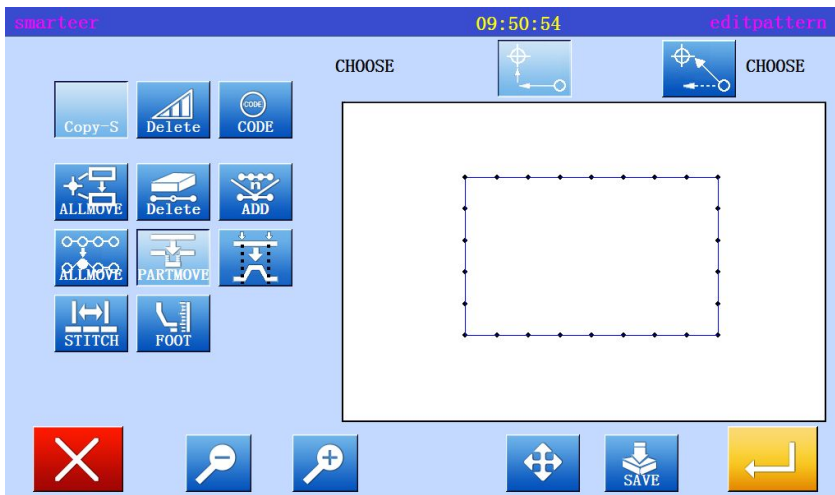



* Enter modify mode

* Press  and .

* Press , open the next screen.

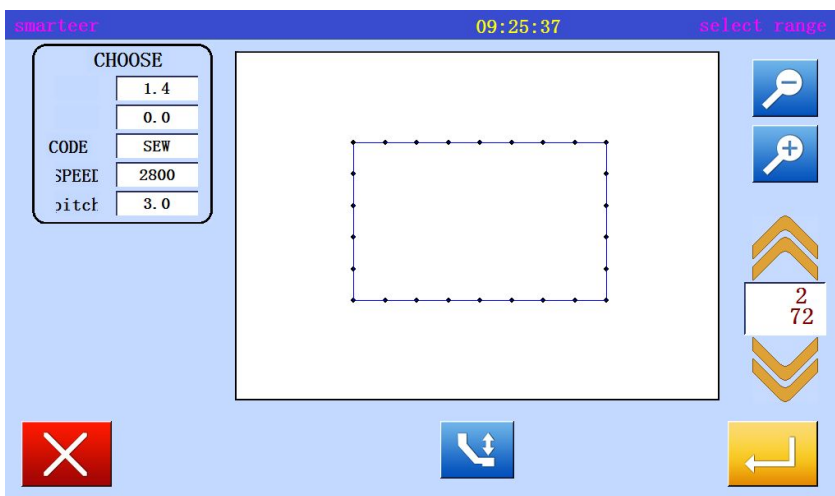
2、 Decided to modify the scope (starting point)



* Use , determine the location to be modified (D point).

* Press .

3、 Decided to modify the scope(end)

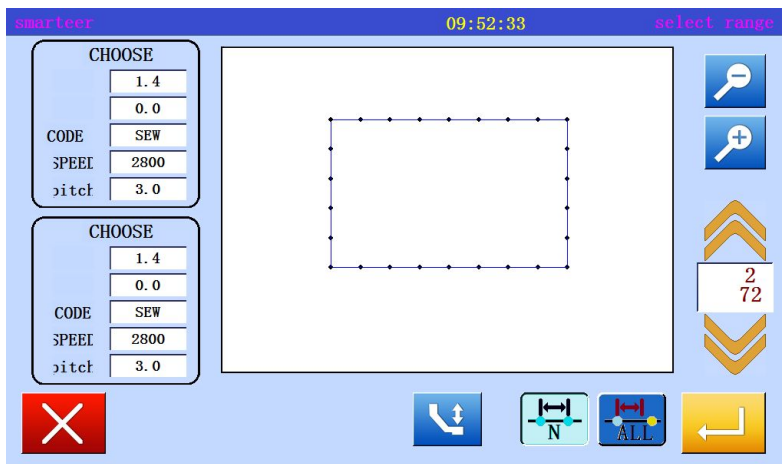

* Used  to determine the location of the terminal.

* Press .

4、 Set moving method and needle distance

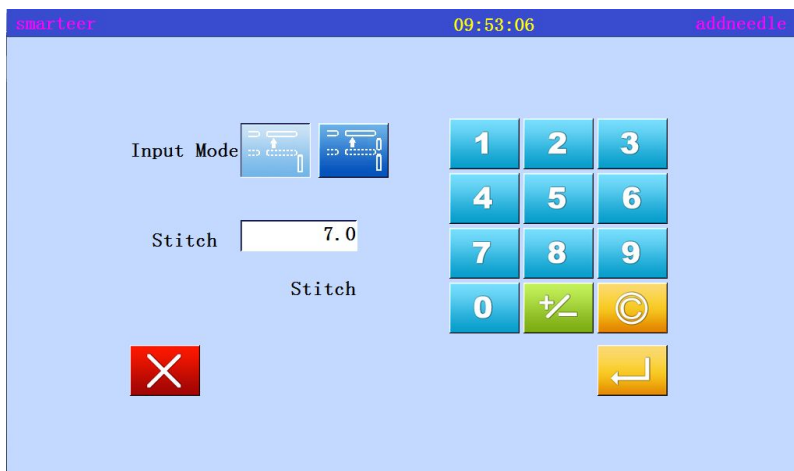

* Set moving mode. Press



* Set stitch (in this case, set to 3.0mm)

* Press .

5、 Determine the number of moves

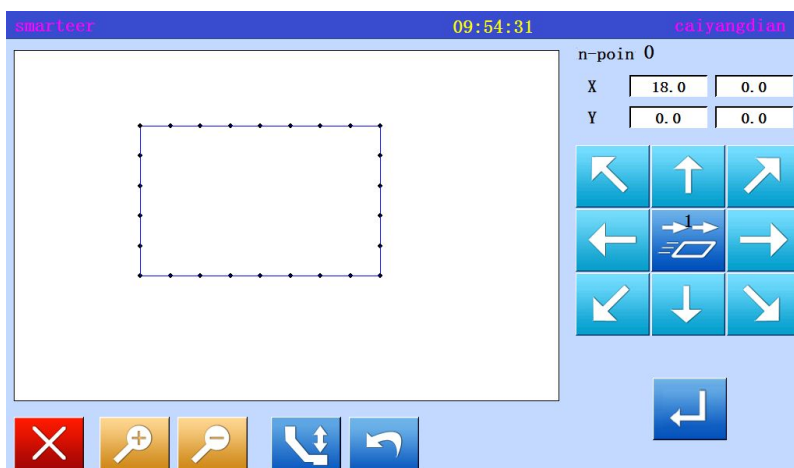

* With the arrow keys, determine the number of moves. (move to position D ').

* Press .

6、 Confirmation after modification

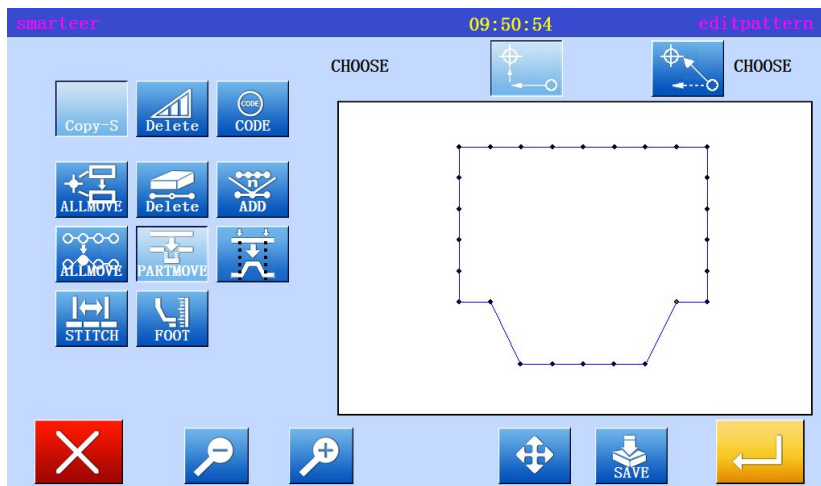

* Exit modification mode.

Press  to return to the standard screen.

(12) Modify a paragraph (add new data to the front / back data)

[example] in the following types of sewing, the D point and E point between the parts will be moved to the D' point and E' point. At this point, D' - E' points in front or back of the data will add new data. (D point to D' point, E point to E' point).

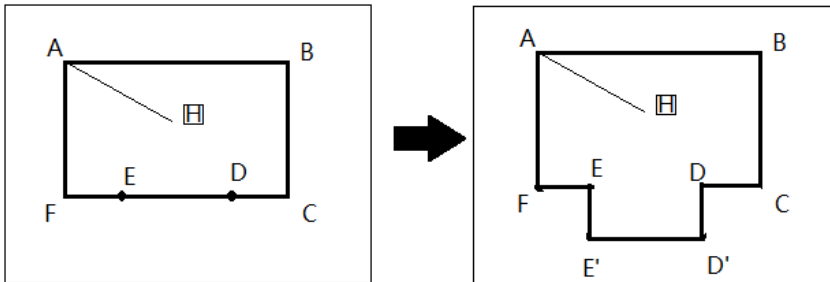

Operational details

1、 Select segment move

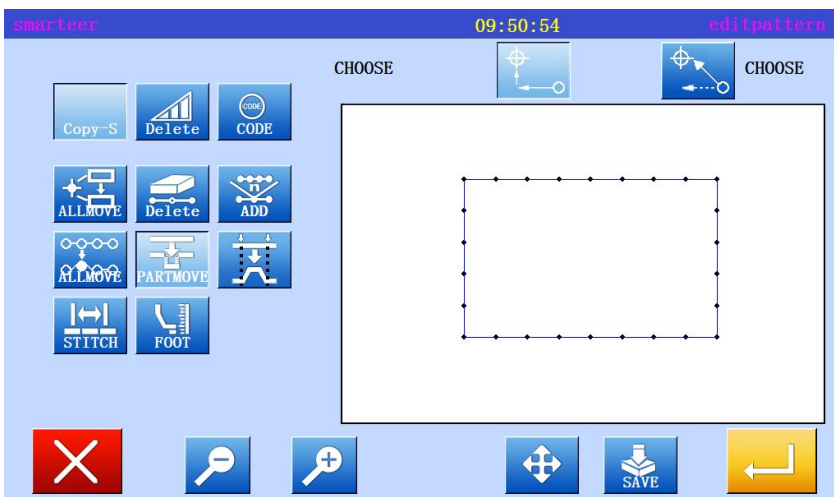



* Enter modify mode

* Press  and .

* Press , open the next screen.

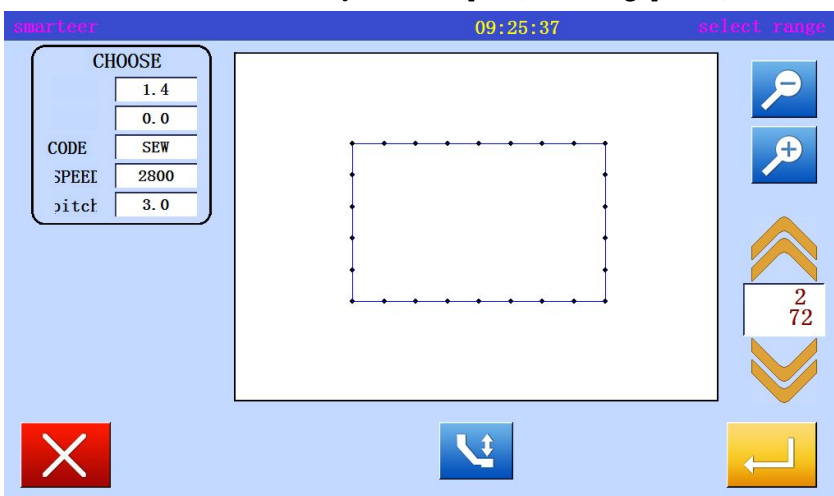
2、 Decided to modify the scope (starting point)



* Use , determine the location to be modified (D point).

* Press .

3、 Decided to modify the scope(end)

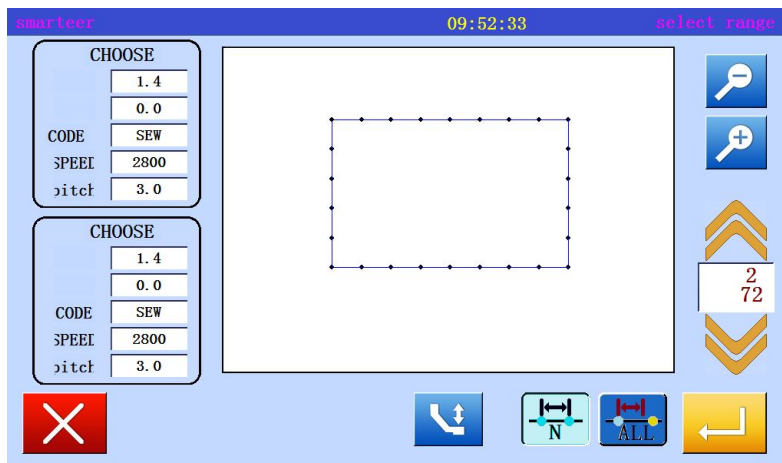

* Used  to determine the location of the terminal. (E point)

* Press .

4、 Set moving method and needle distance

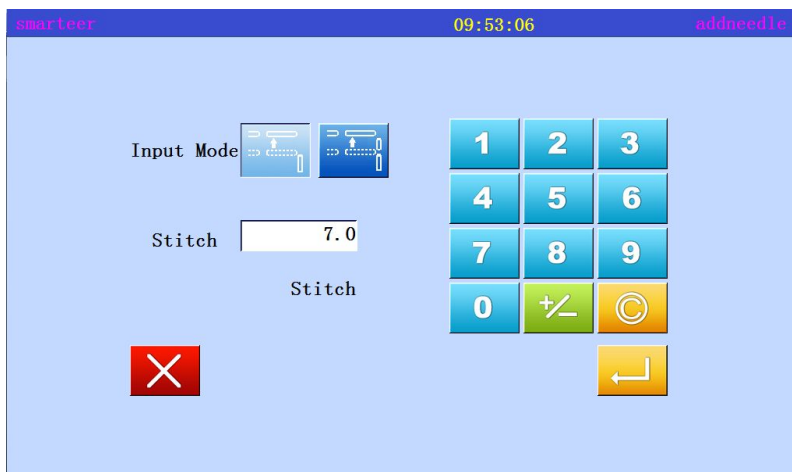

* Set moving mode. Press .

* Setting pin distance. (in this case, set to 3.0mm)

* Press .

5、 Determine the number of moves

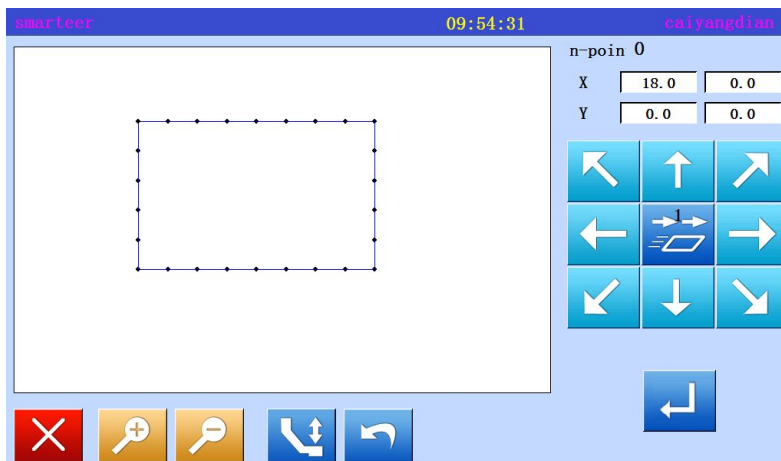

* With the arrow keys, determine the number of mobile. (move to position (D ')).

* Press .

6、 Confirmation after modification

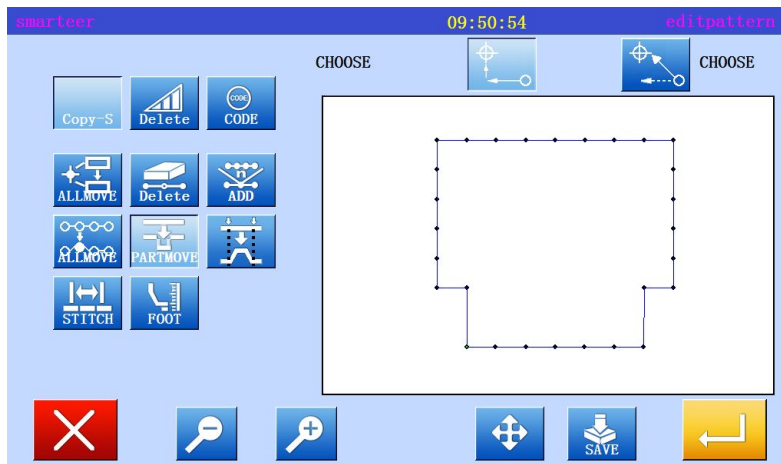

* Exit modification mode.

Press  to return to the standard screen.

(13) Section modification 1 (linear input)

[example] in the following types of sewing, A points, B points between the parts is modified into a straight line.

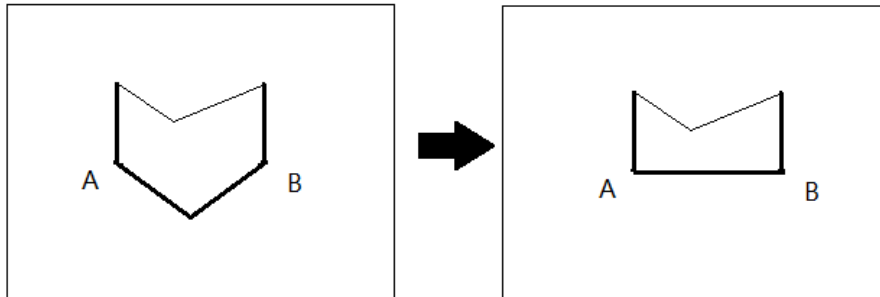

Operational details

1、 Select section to modify

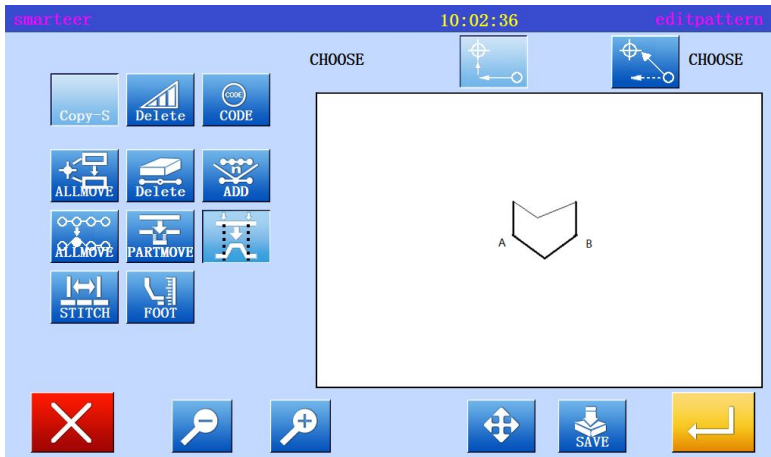

* Enter modify mode

* Press  and .

* Press , open the next screen.

2、 Select input type



* Press .

* Press  key, set data

3、 Decided to modify the scope (starting point)

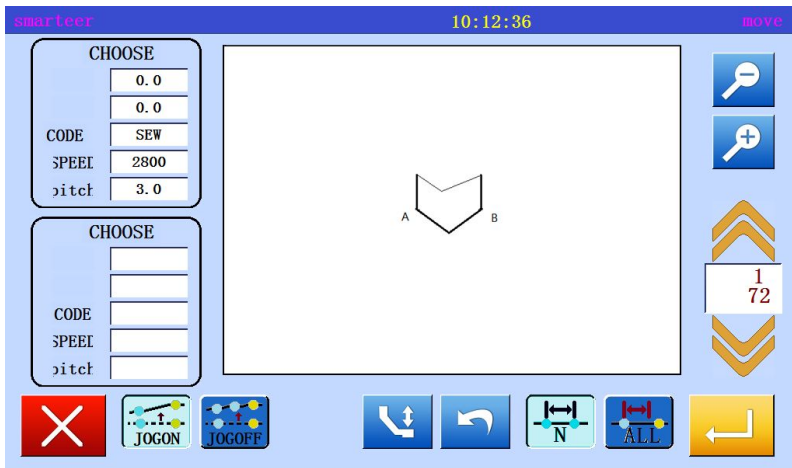

* Used  to determine the location of the starting point. (A point)

* Press .

4、 Set section modification (end)

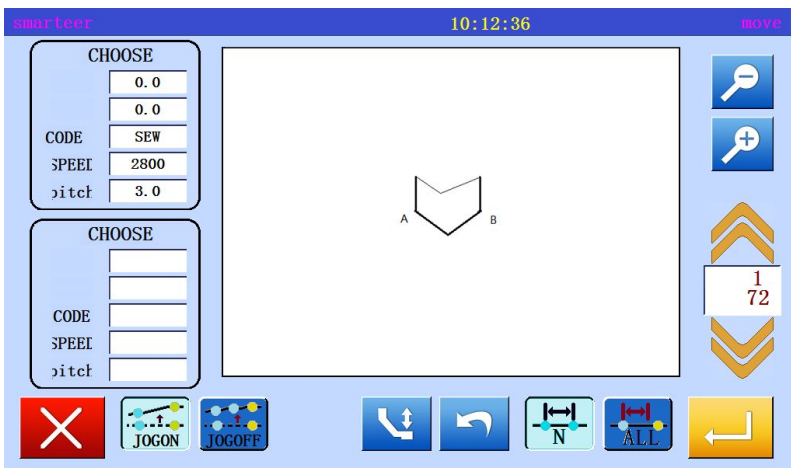

* Used  to determine the location of the terminal. (B point) .

* Press .

5、 Determine the number of moves

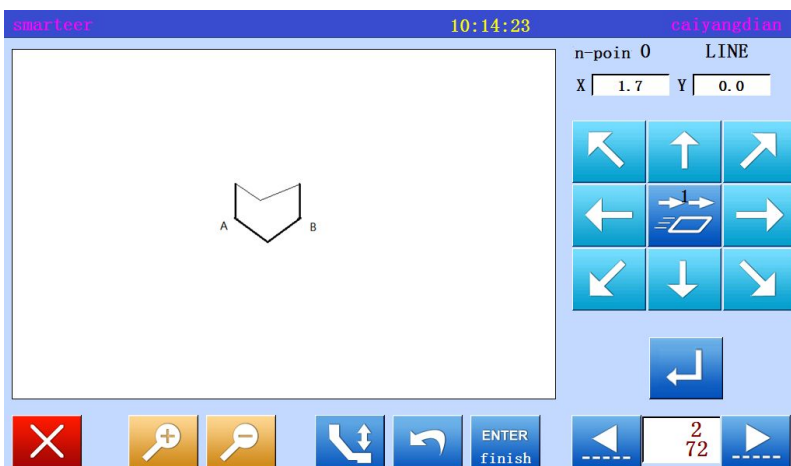

* Press .

6、 Confirm data after modification

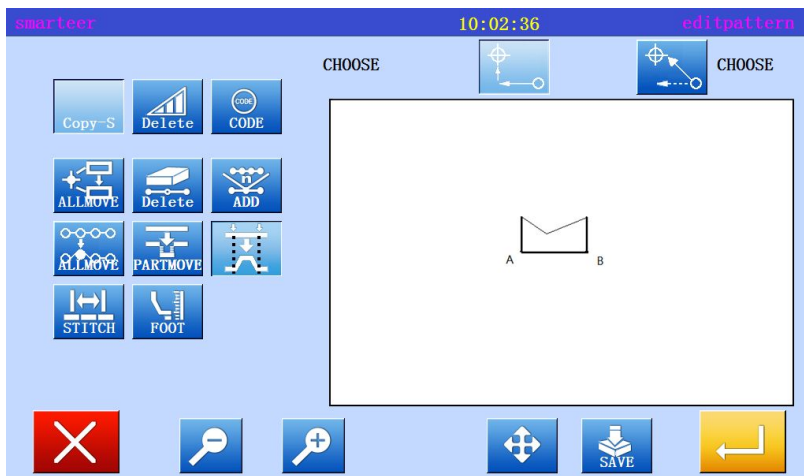

* Exit modification mode.

Press  to return to the standard screen.

(14) Section modification 2(Polygons, arcs, curves)

Method for specifying a modified location using a mobile key . It is more convenient to use the original data as a reference.

[example] in the following types of sewing, C points and D points one by one to be replaced by C' and D' points.

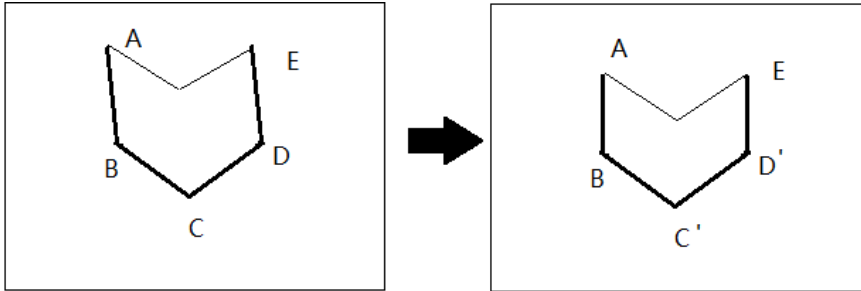

Operational details

1、 Select section to modify

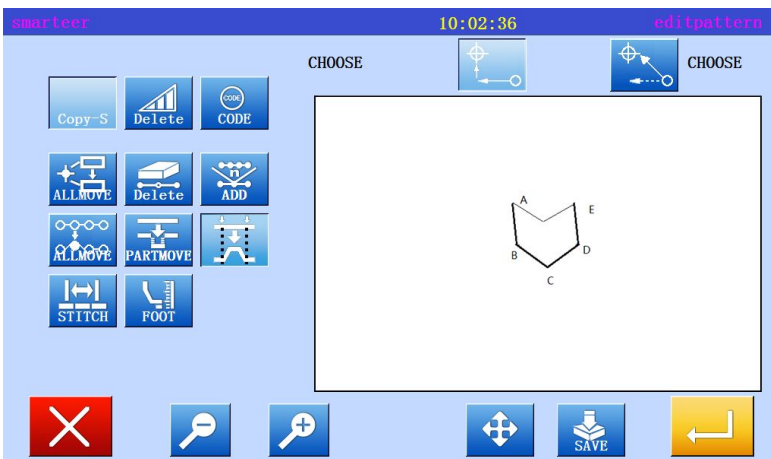

* Enter modify mode

* Press  and .

* Press , open the next screen.

2、 Select input type

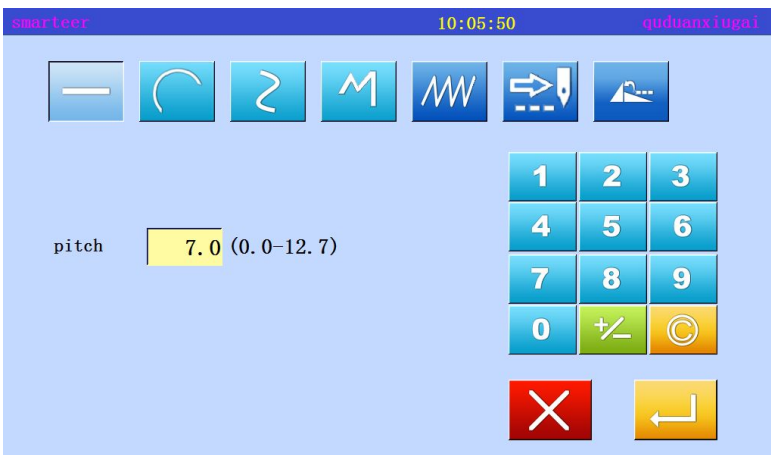

* Press .

* Press  key, set data.

3、 Set section modification (starting point)

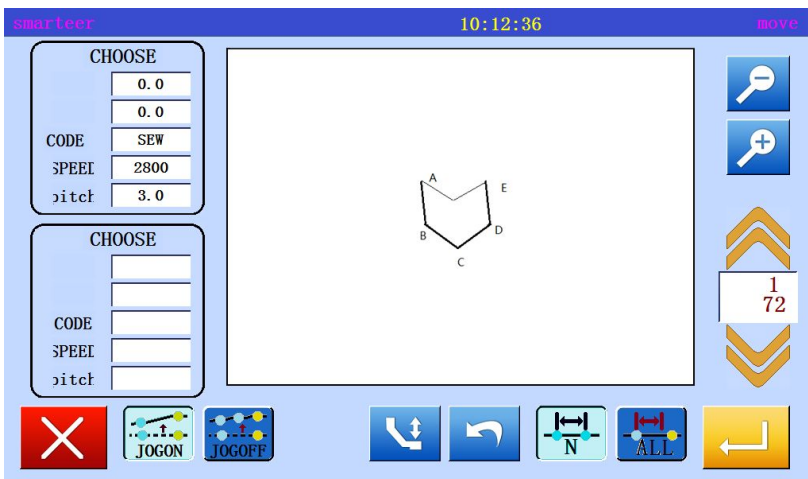

* Used  to determine the location of the starting point. (B point)

* Press .

4、 Set section modification (end)

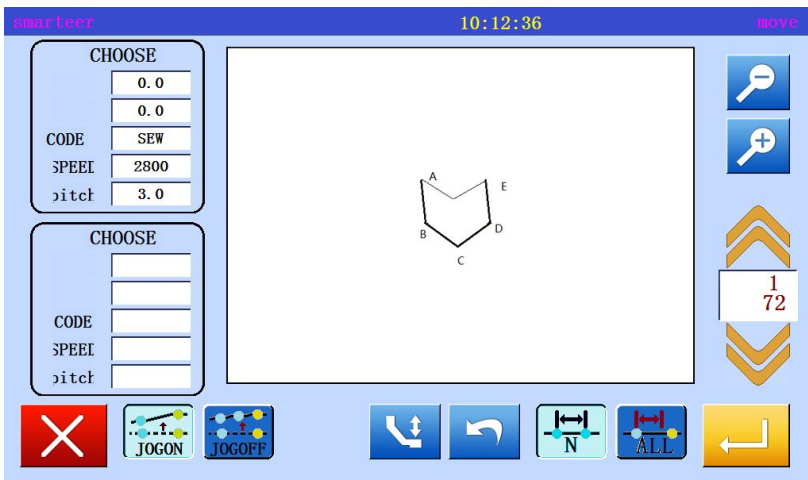

* Used  to determine the location of the end point. (E point)

* Press .

* Press .

5、 Move and set the needle position

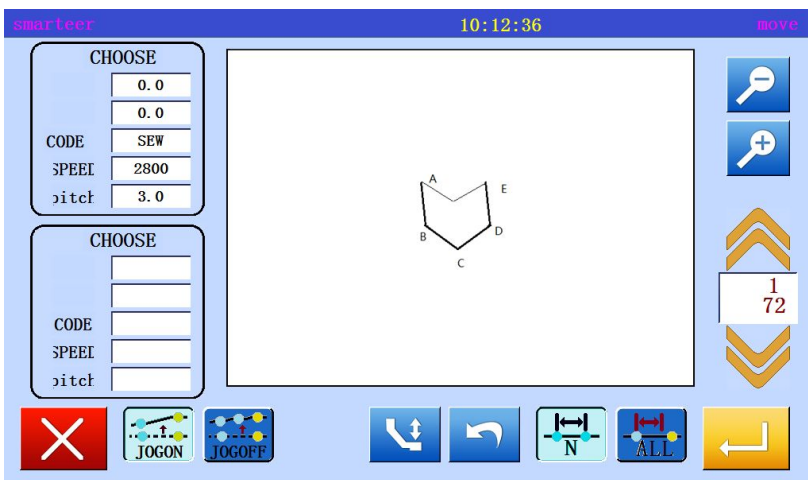

* Use , move to the position to be modified (C point)

* Press .

6、 To modify the needle position to change the position, setting the data

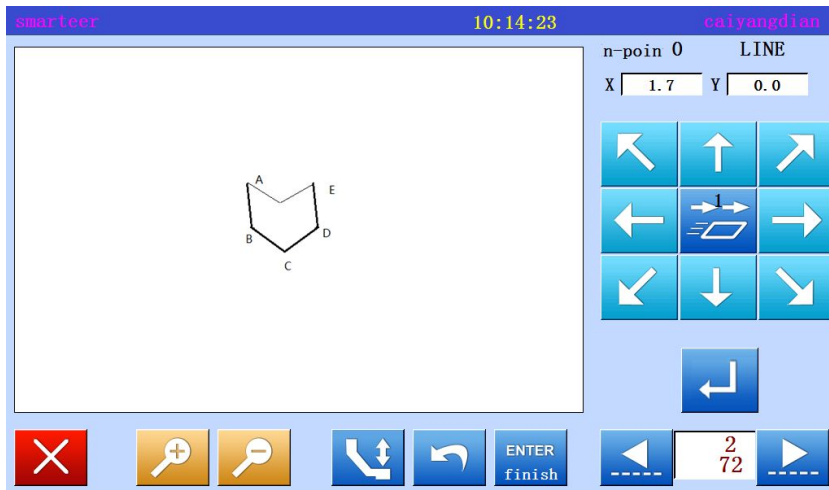

* Press the arrow keys to change the position. (C' point)

* If there are several locations to be modified, repeat the fifth step and the sixth step. Enter the number of points will be increased (here, the same from the D point to the D point)

7、 Exit position modification

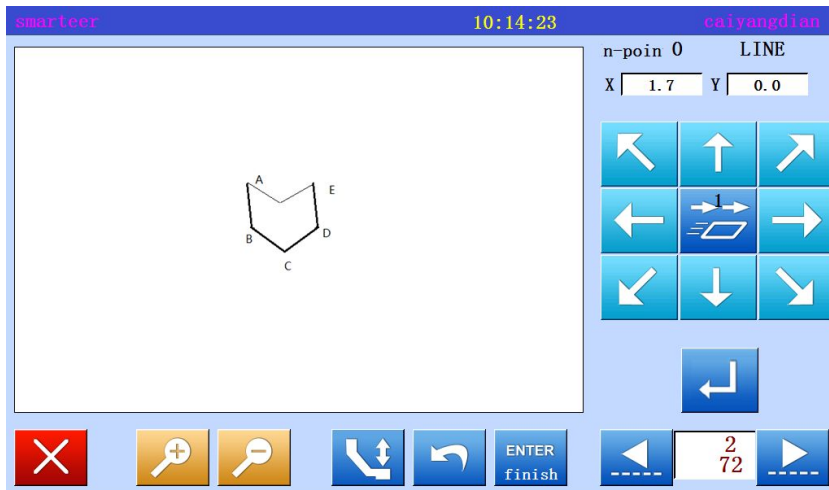

* Specify all modified positions,

press .

8、 Confirm data after modification

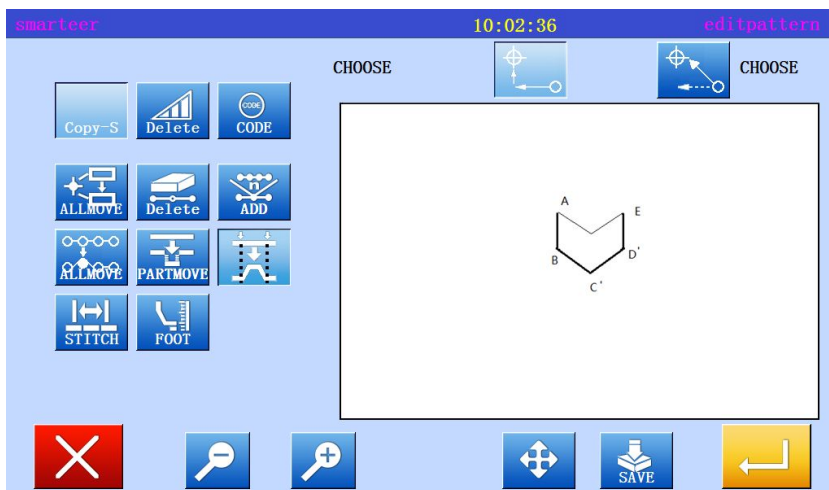

* Exit modification mode.

Press  to return to the standard screen.

Do not move to the key to specify the modified location (for new data)

The first step to the third step is the same as the modified position with the move key. The fourth step and the following steps are explained as follows.

4、 To modify the needle position to change the position, setting the data

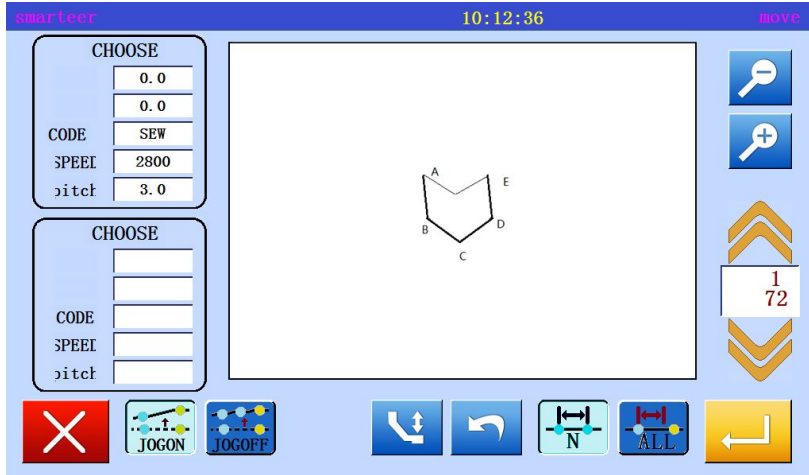

* With the mobile key , to determine the starting point (B point) and the end point (E point).

* Press 

* Press 

5、 Mobile and decided to modify the scope

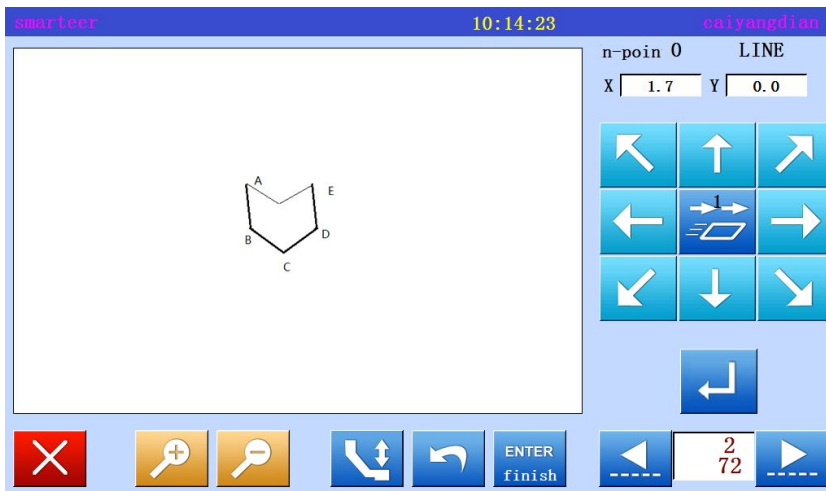

* With the arrow keys, modify the location. (move to C 'point).

* Press 

* If there are several locations to be modified, repeat the fifth step. The number of input points will increase. (Modify D 'point)

* Press 

6、 Confirm data after modification

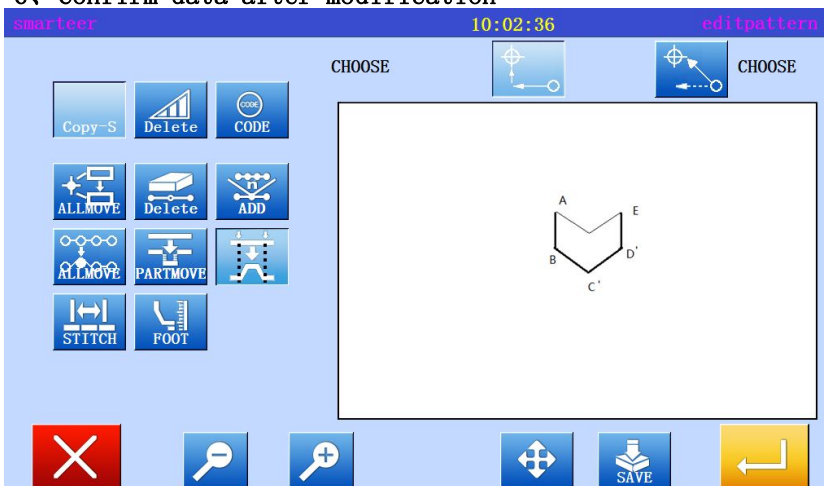

* Exit modification mode.

Press  to return to the standard screen.

(15) Section modification 3(zigzagsewing input)

[example] in the following types of sewing, the A point and the B point between the parts is modified into a Z font.

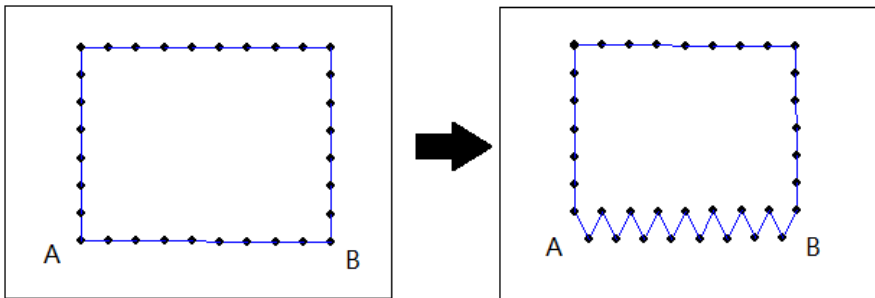

Operational details

1、 Select section to modify

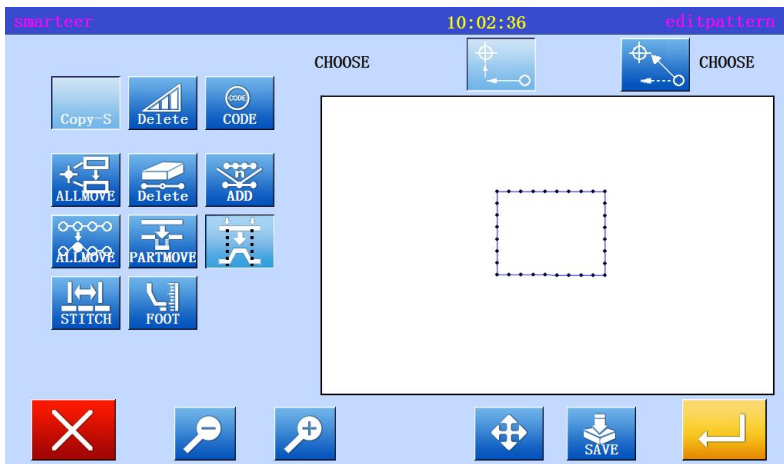

* Enter modify mode

* Press  and .

* Press , open the next screen.

2、 Select input type

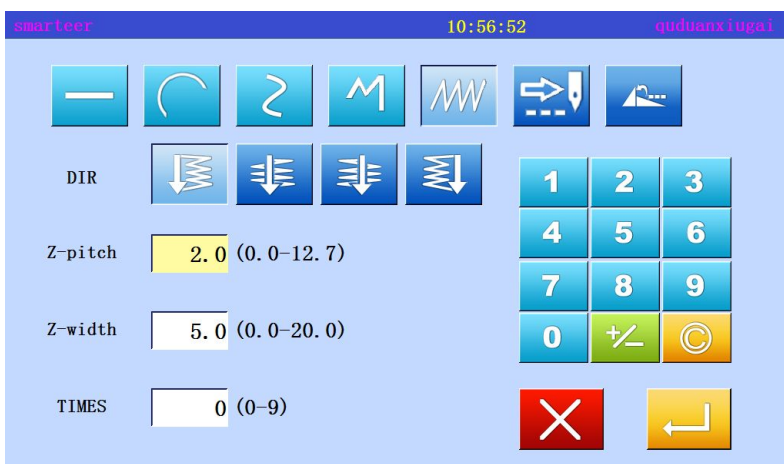



* Press .

* Set the zigzagsewing length and width, establishing direction. Set width: 5.0mm miter gauge: 3.0mm building direction: right

* Press  key to set data

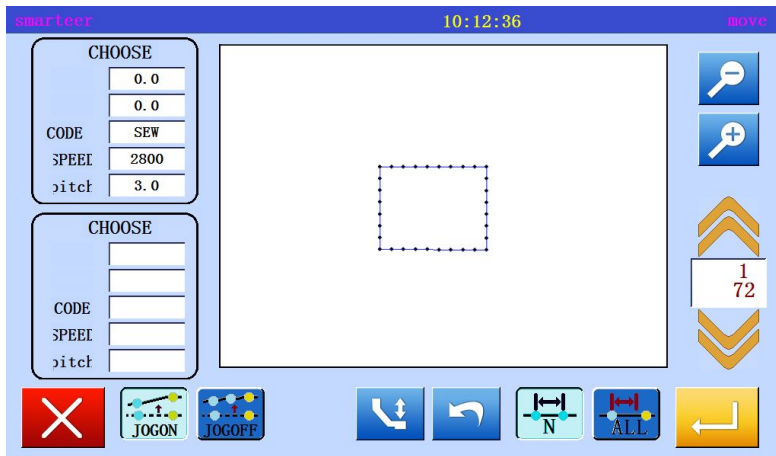
3、 Set section modification (starting point)



* Used  to determine the location of the starting point. (A point)

* Press .

4、 Set section modification (end)

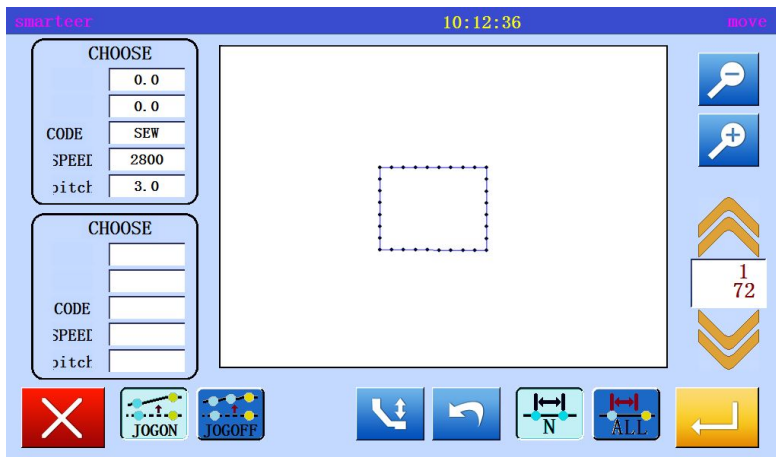

* Used  to determine the location of the end point. (B point)

* Press .

5、 Confirm data after modification

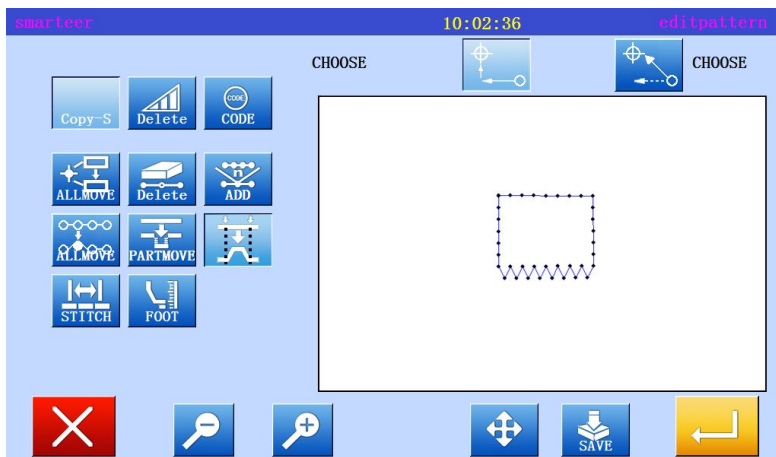

* Exit modification mode.

Press  to return to the standard screen.

(16) Section modification 4(change data)

Method for specifying a modified location using a mobile key. It is more convenient to use the original data as a reference.

[example] in the following types of sewing, E points F points were changed one by one to E ' and F' points.

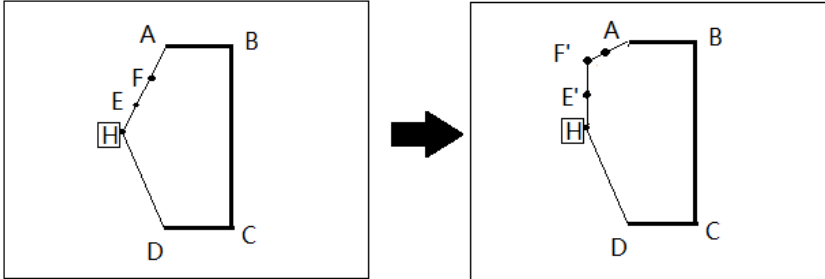

Operational details

1、 Select section to modify

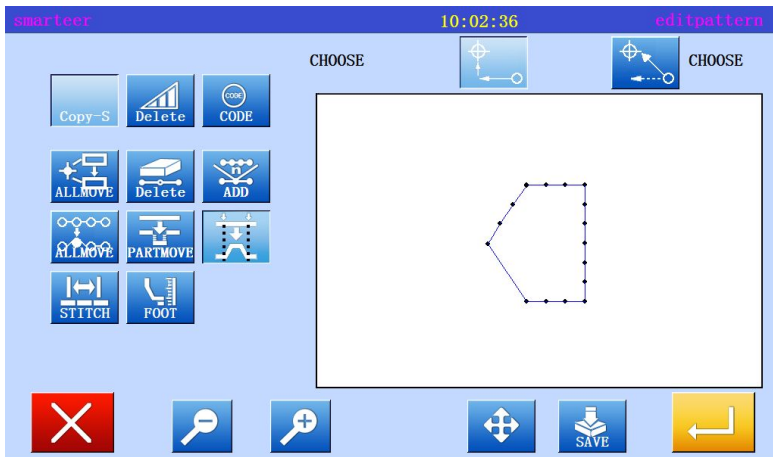

* Enter modify mode

* Press  and .

* Press , open the next screen..

2、 Select input type



* Press .

* Press  key, set data.

3、 Set section modification (starting point)

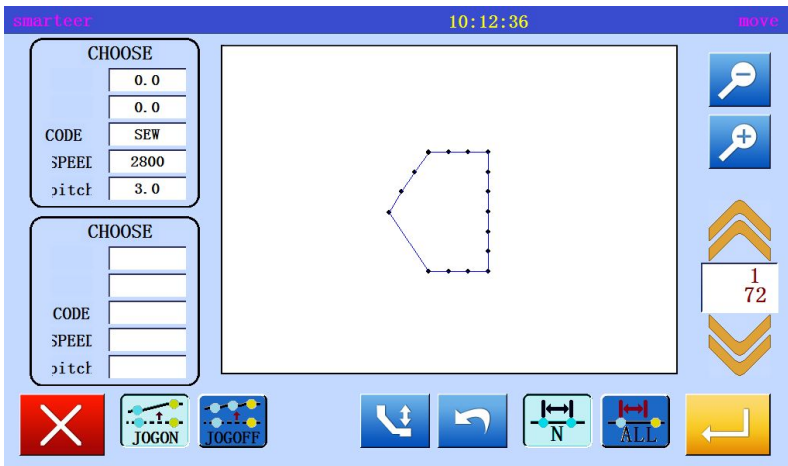

* Used  to determine the location of the starting point. (origin)

* Press .

4、 Set section modification (end)

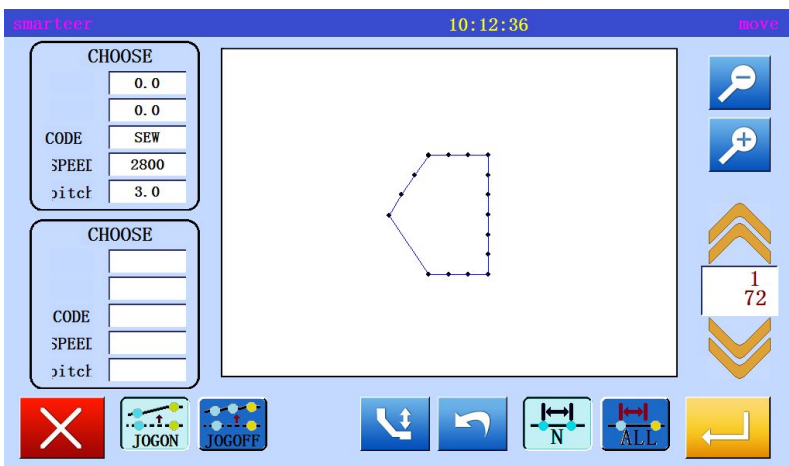

* Used  to determine the location of the end point. (A point)

* Press .

* Press .

5、 Move and set the needle position

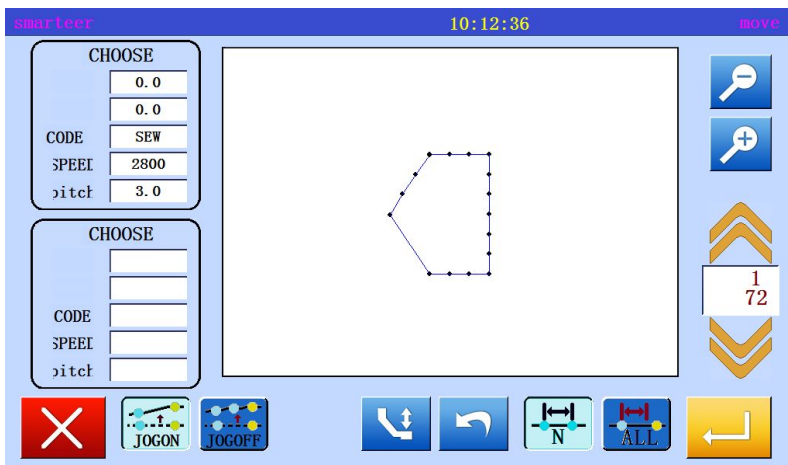

* Use, move to the position to be modified (E point)

* Press .

6、 To modify the needle position to change the position, setting the data

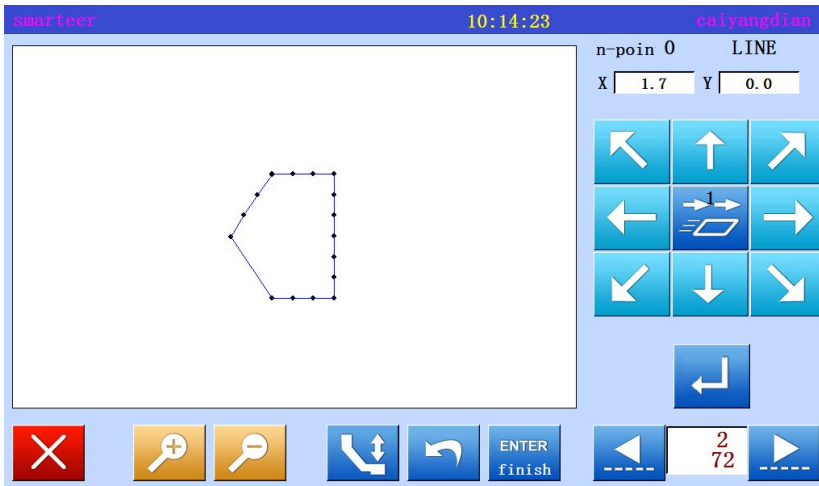

* Press the arrow keys to change the position. (E 'point).

* If there are several locations to be modified, repeat the fifth step and the sixth step. Enter the number of points will be increased (From the F point to the F point)

* Press .

7、 Exit position modification

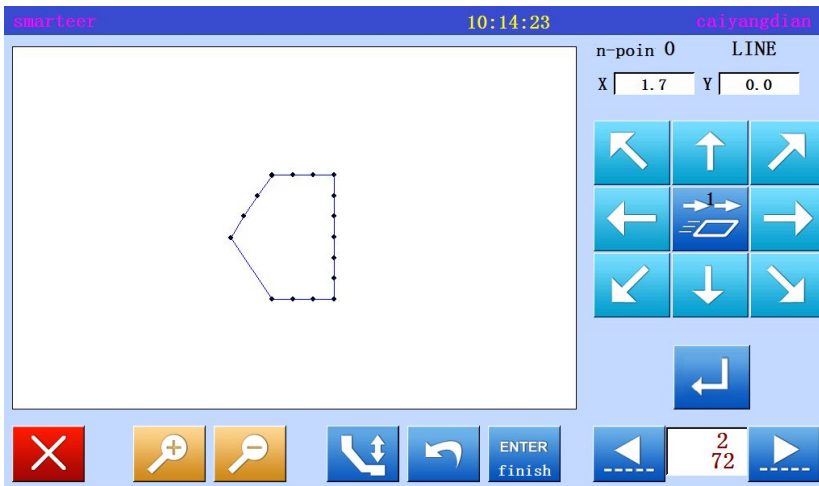

* Press .

8、 Confirm data after modification

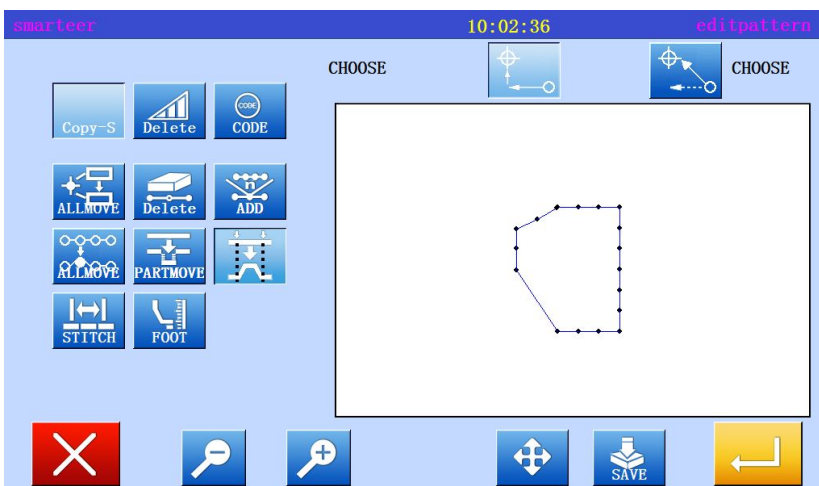

* Exit modification mode.

Press  to return to the standard screen. .

Do not move to the key to specify the modified location (for new data)

From the first step to the third step with the move key to specify the same modification of the location of the same. The fourth step and the following steps are explained as follows. (reference "paragraph 3 of the different mobile key to modify the location")

[example] the sewing type of E and F will be deleted, G-spot is new, and modify the data transfer.

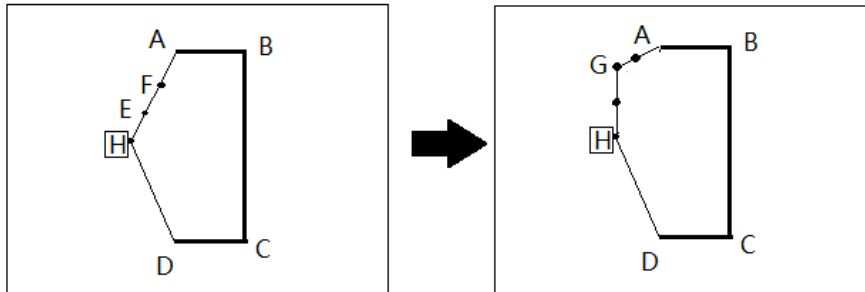

The first step to the third step ahead of similar section "mobile key specified position changes".

4、 To modify the needle position to change the position, setting the data.

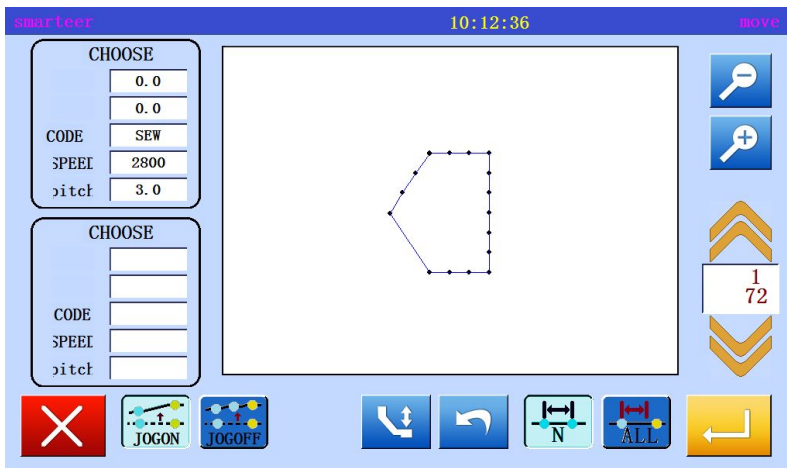

*With the mobile key , to determine the starting point (B in situ) and the end point (A point).

* Press .

* Press .

5、 Mobile and decided to modify the scope

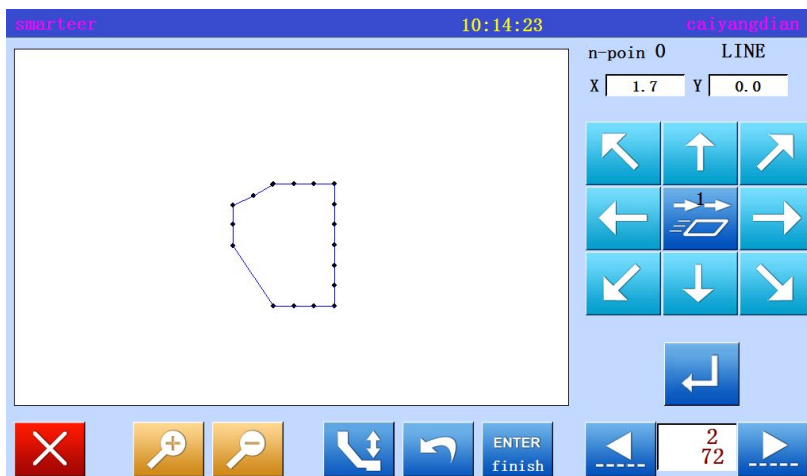

* With the arrow keys, modify the location. (move to G).

* Press .

* If there are several locations to be modified, repeat the fifth step. The number of input points will increase.

* Then press .

6、 Confirm data after modification

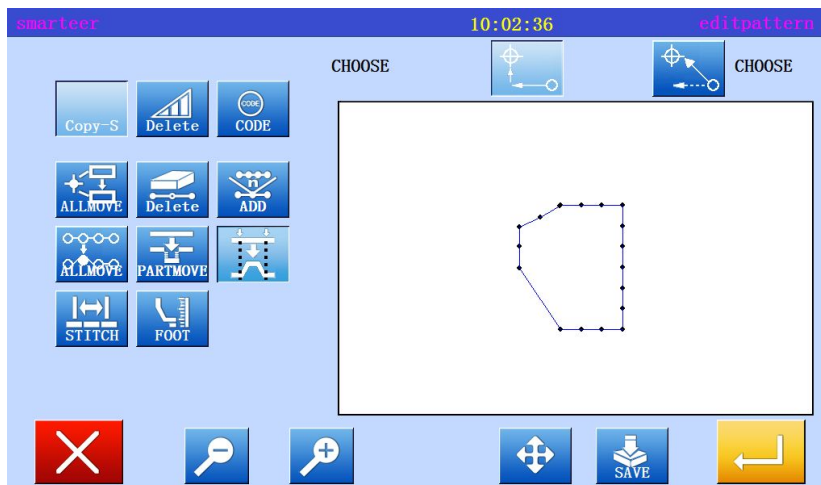

* Exit modification mode.

Press  to return to the standard screen.

(17) Modify the needle distance (the number of the specified number of pins)

[example] as shown below, sewing data A points, B points between the needle is modified.

(3.00mm-7.00mm)

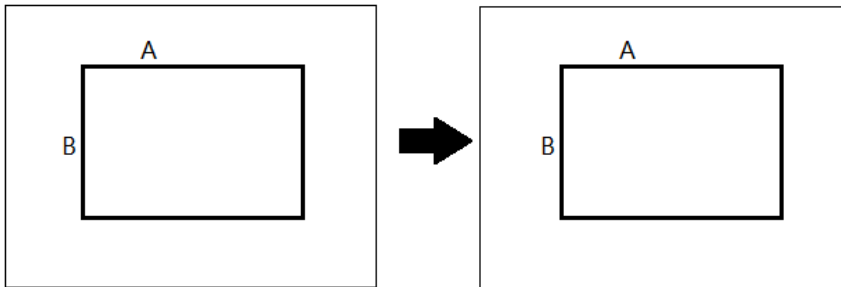

Operational details

1、 Selection of needle pitch modification

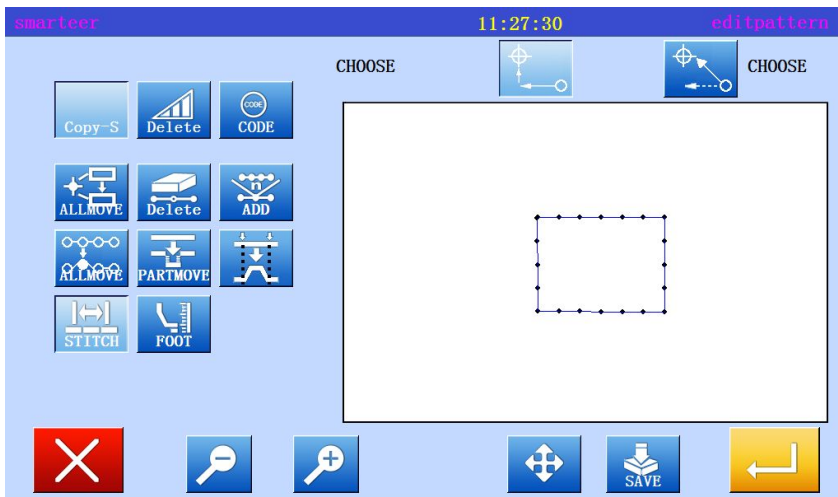



* Enter modify mode

* Press  and .

* Press , open the next screen.

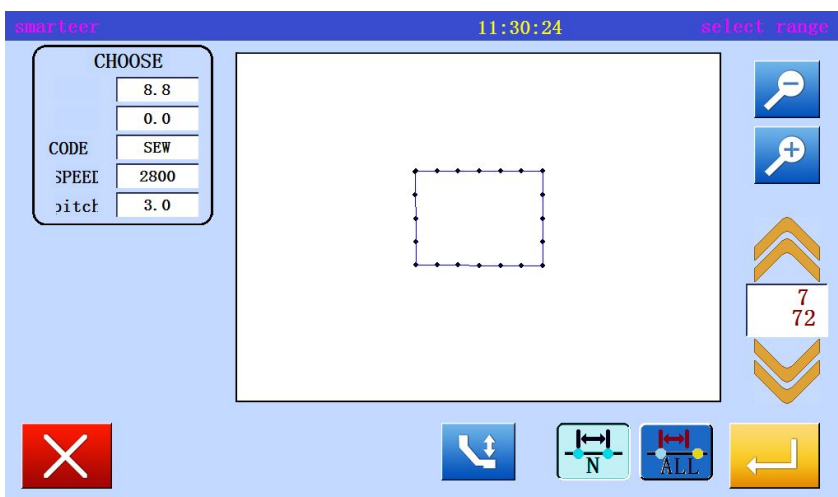
2、 Modify the starting position



* With , decided to modify the location, set the position to start to modify (A point).

* Press .

3、 Set the number of changes and modifications

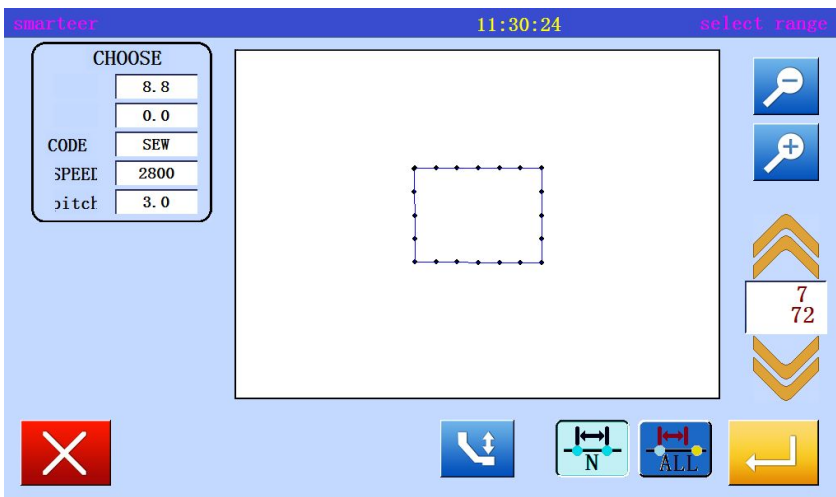

* Setting mode



Specifies the number of pins to modify



All the steps after the specified location

(Press )

When modifying the specified range, the number of the sewing is set. ("15 needles") Set stitch (7.00mm)



* Press .

4、 Confirmation after modification

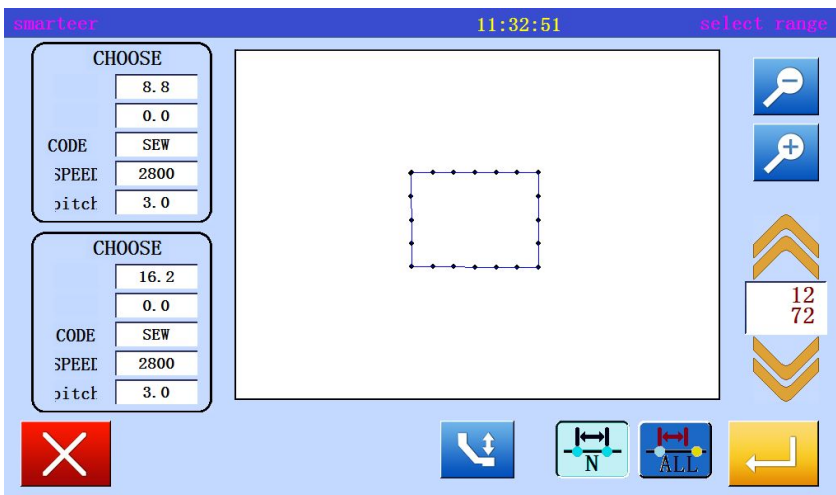

* Exit modification mode.

Press  to return to the standard screen.

(18) To modify the needle distance (all the steps after the specified position)

[example] as shown below, sewing data A points, B points between the needle is modified.

(3.00mm-7.00mm)

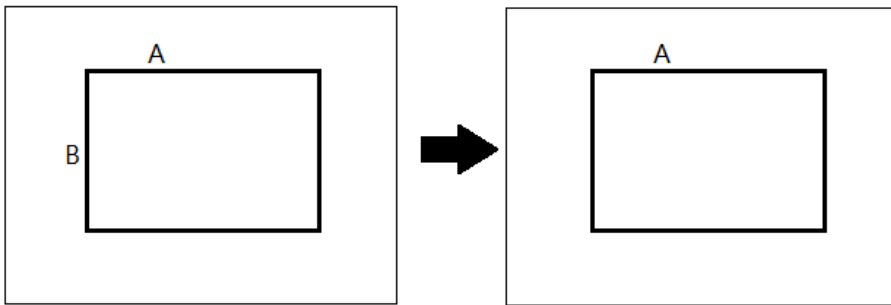

Operational details

1、 Selection of needle pitch modification

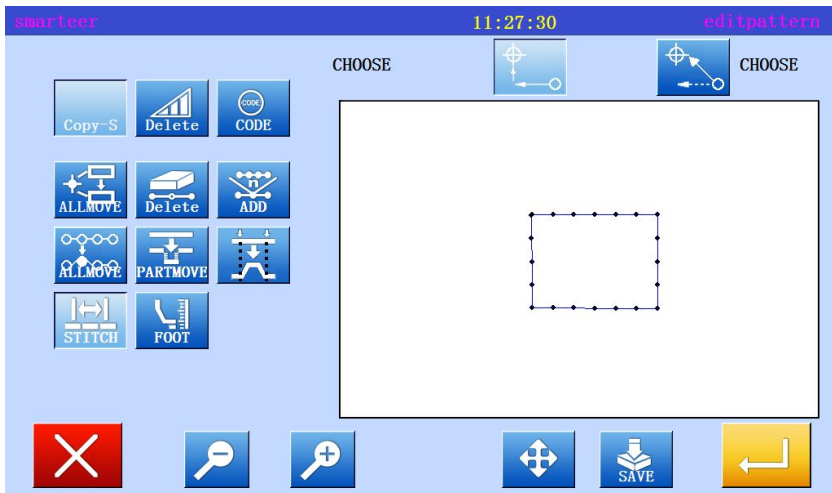



* Enter modify mode

* Press  and .

* Press , open the next screen.

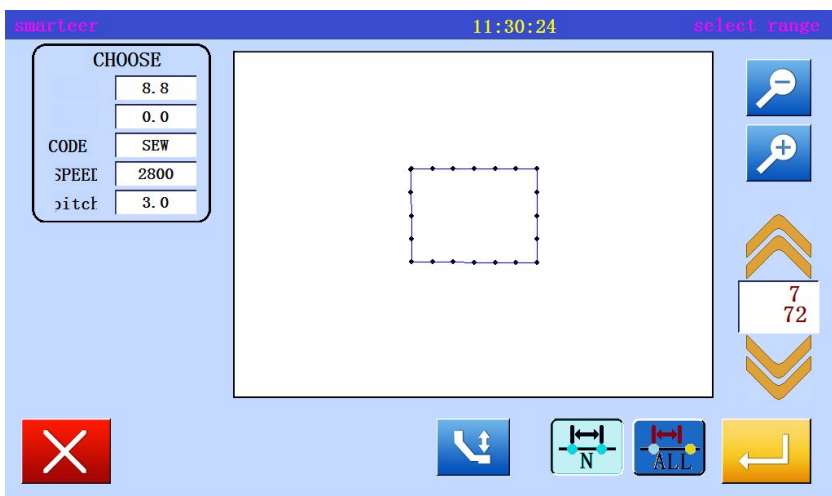
2、 Modify the starting position



* With , decided to modify the location, set the position to start to modify (A point).

* Press .

3、 Set the number of changes and modifications

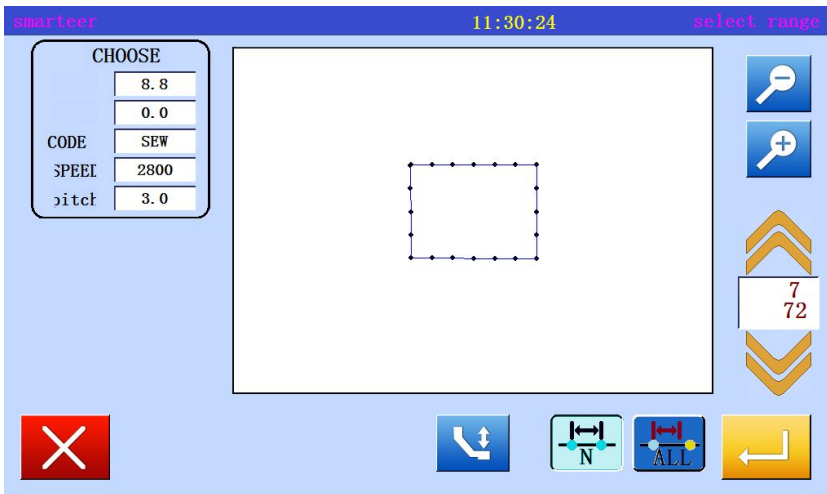

* Setting mode



Specifies the number of pins to modify



All the steps after the specified location

(Press )

When modifying the specified range, the number of the sewing is set. ("15 needles") Set stitch (7.00mm)

4、 Confirmation after modification

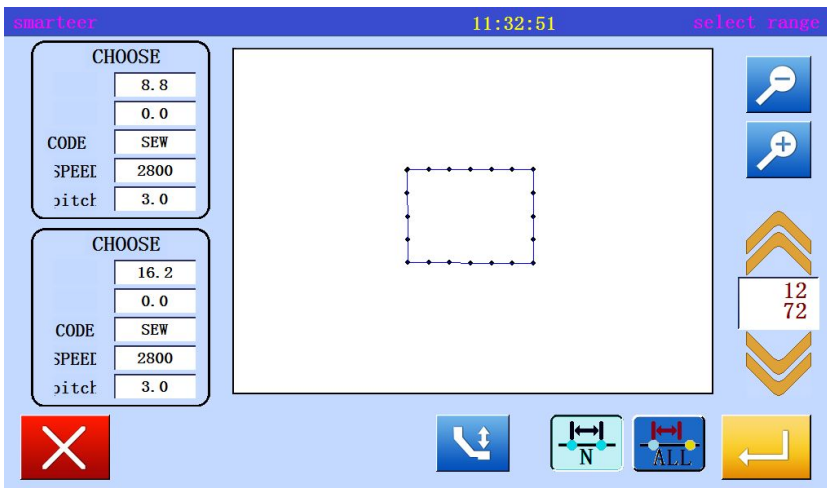

* Exit modification mode.

Press  to return to the standard screen.

(19) Modify the needle step speed (all parts after the specified position)

[example] in the following types of sewing, the sewing speed at all parts of the B point is modified to the high speed. (MIDI)

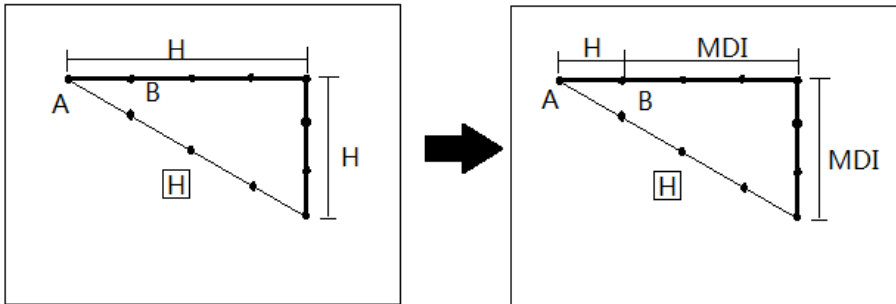

Operational details

1、 Select the needle step speed change

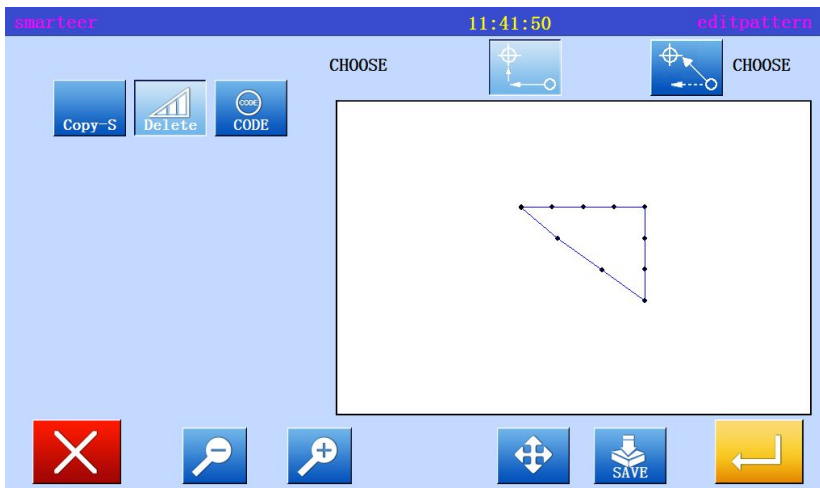



*Enter modify mode

* Press 

* Press , open the next screen

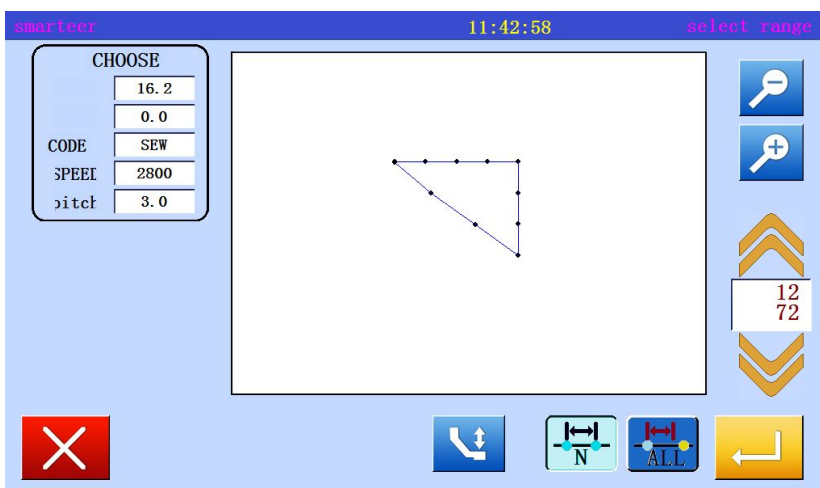
2、 Modify the starting position



* With , decided to modify the location, set the position to start to modify (B point).

* Press .

3、 Set change mode and speed

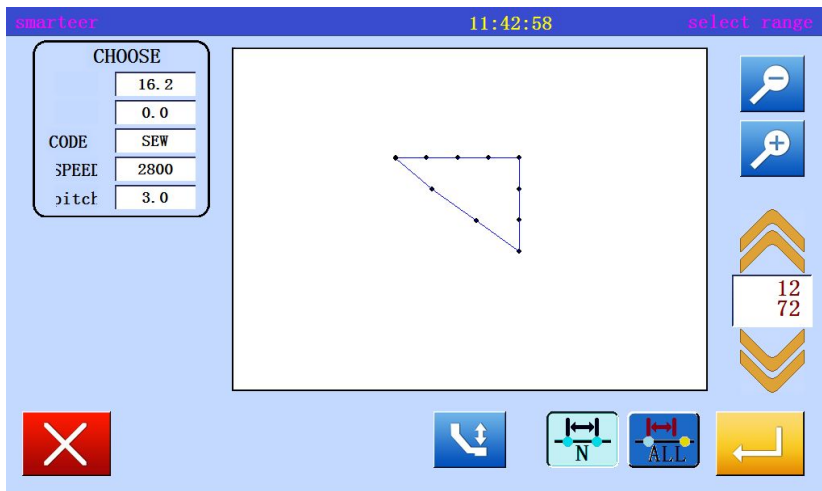

* Press 

* Press 

4、 Confirmation after modification

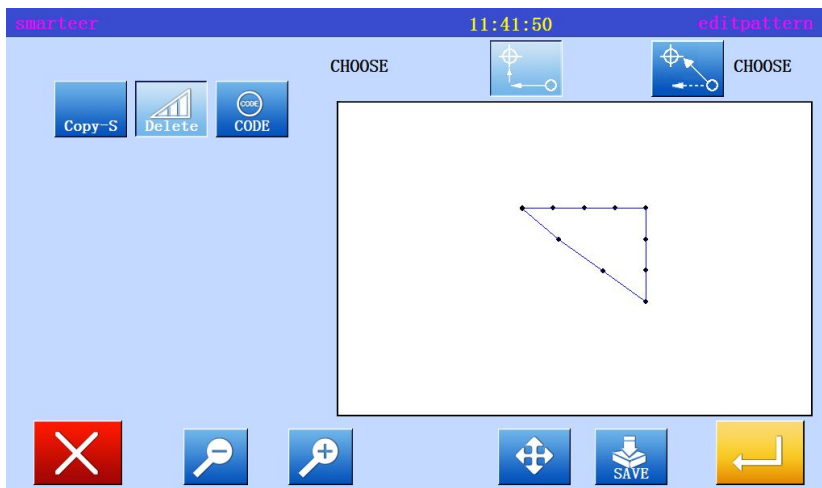

* Exit modification mode.

Press  to return to the standard screen

(20) Modify the sewing speed (N pin after the specified position)

[example] in the following types of sewing, the sewing speed of the three stitches after the B point is changed to a high speed. (MIDI)

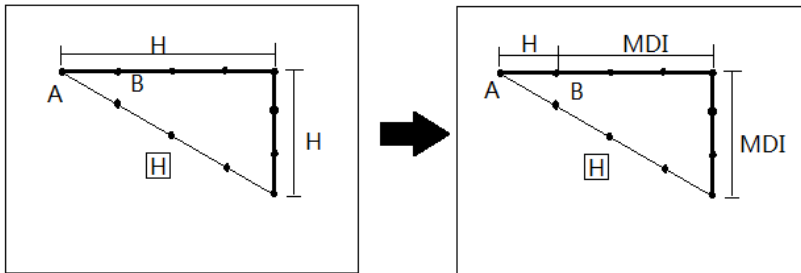

Operational details

1、 Select the needle step speed change

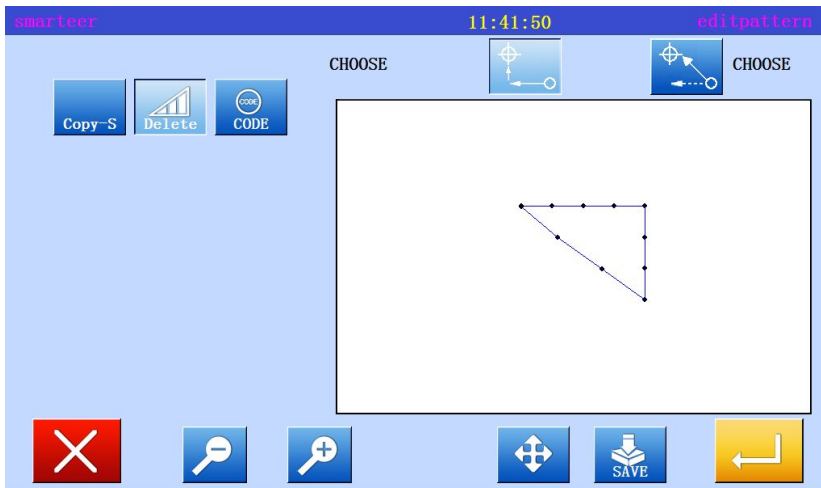



* Enter modify mode

* Press 

* Press , open the next screen

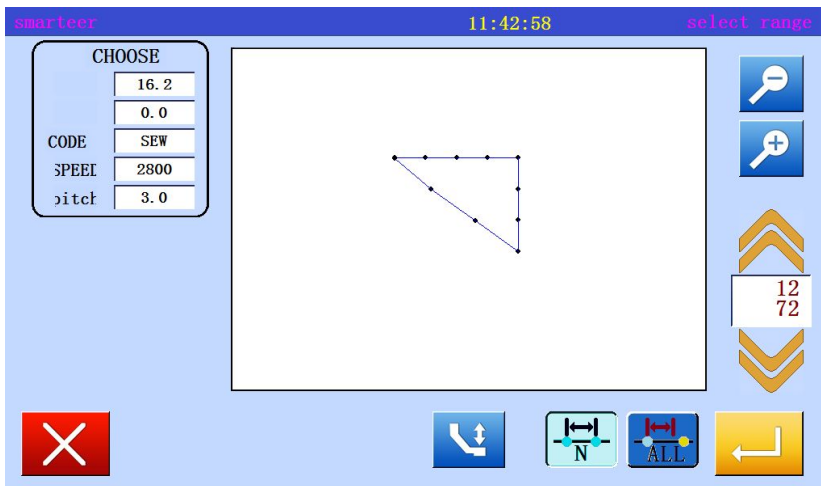
2、 Modify the starting position



* With , decided to modify the location, set the position to start to modify (B point).

* Press .

3、 Set change mode and speed

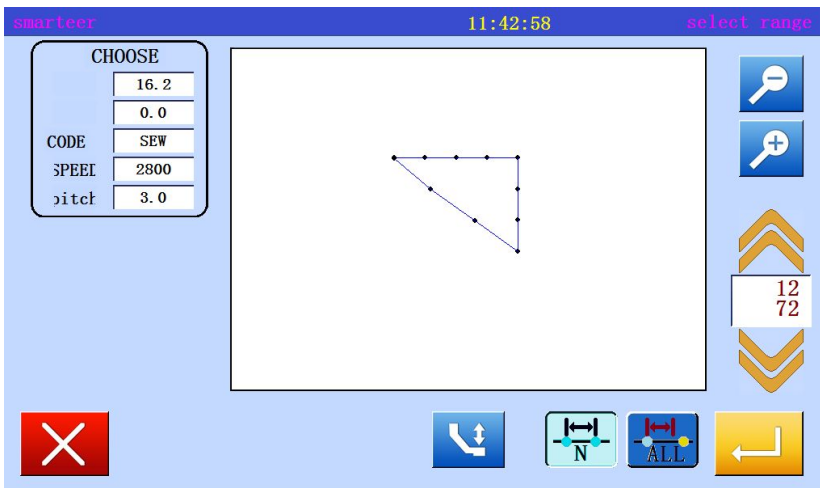

* Press 

* Press 

4、 Modify the starting position

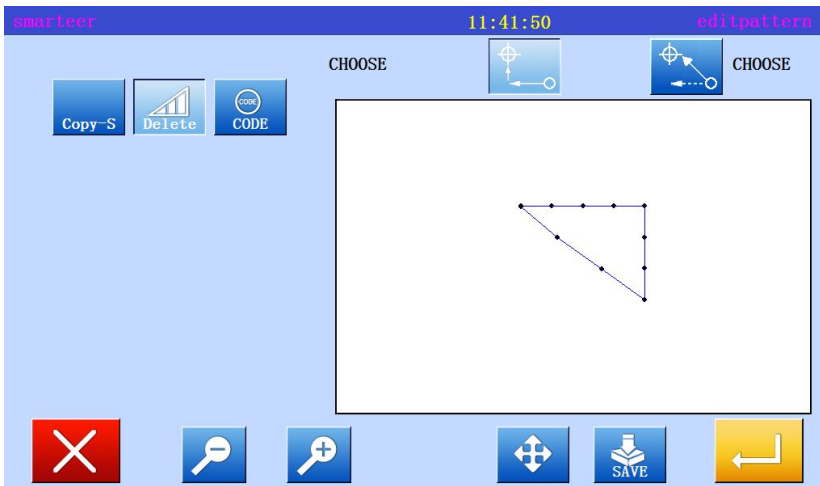

* Exit modification mode.

Press  to return to the standard screen.

(21) Modify code data (add code data)

[example] in the following types of sewing data, "machine needle upper pause" added to the D point

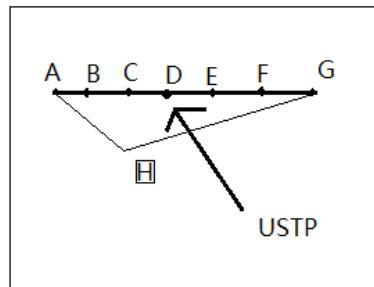

Operational details

1. Select code data to add

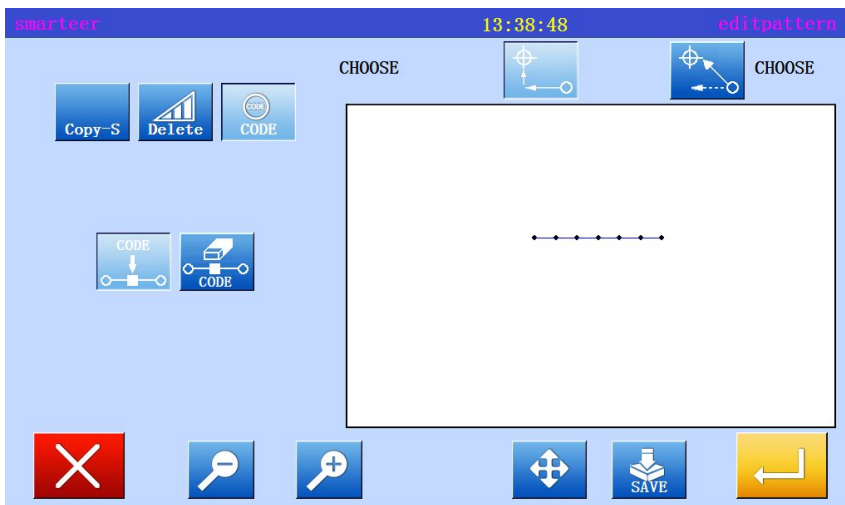

* Enter modify mode

* Press  and .

* Press , open the next screen.

2. Determine the location of the code to add

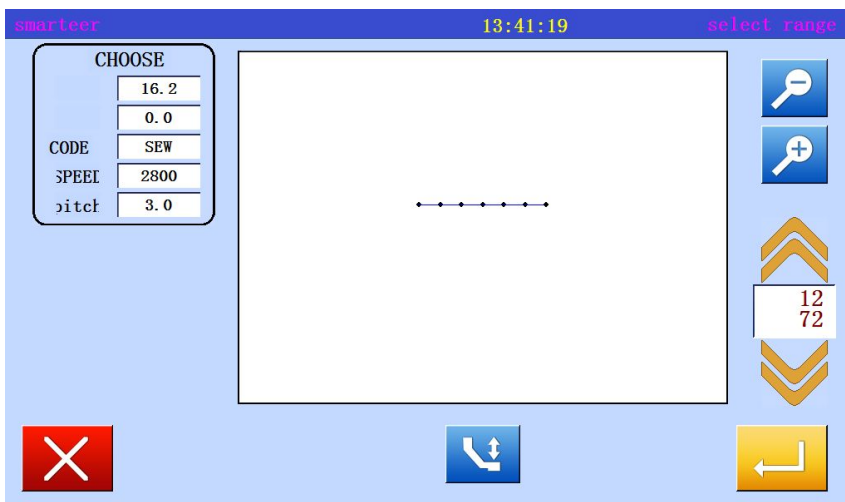

* Used to determine the location of the code to add (D point)

* Press .

3、 Set add code

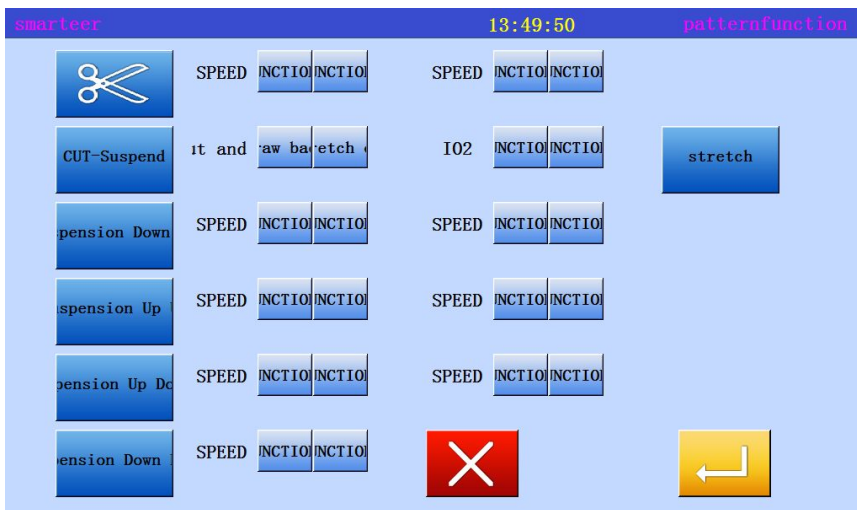

* Press .

* Press .

4、 Confirm execution

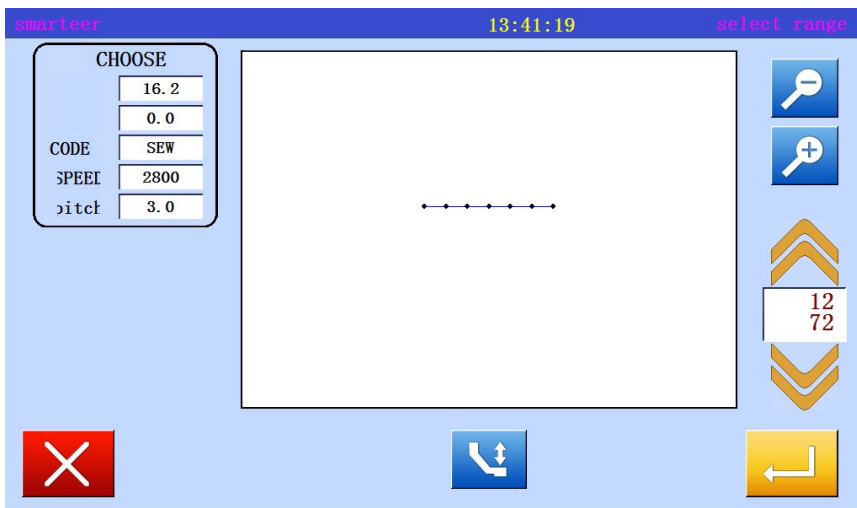

* Press .

5、 Confirm modification

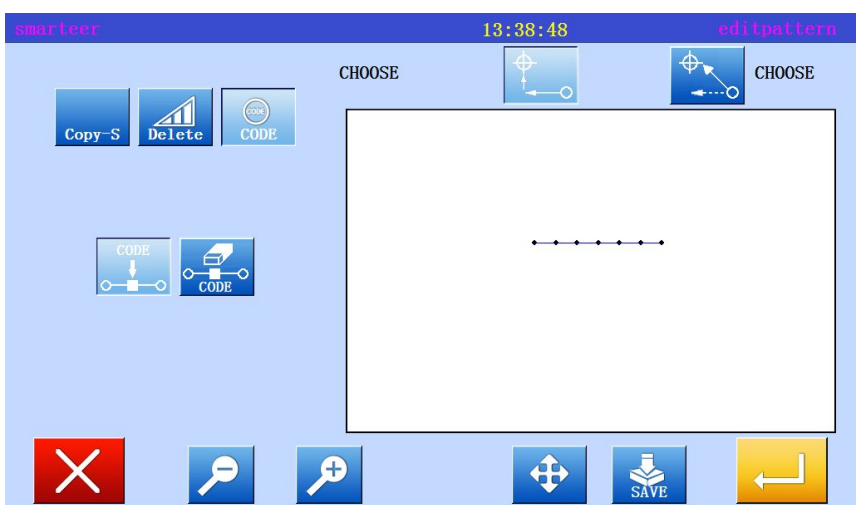

* Exit modification mode.

Press  to return to the standard screen.

(22) Modify code data (delete code data)

[example] in the following types of sewing data, "machine needle upper pause" added to the D point

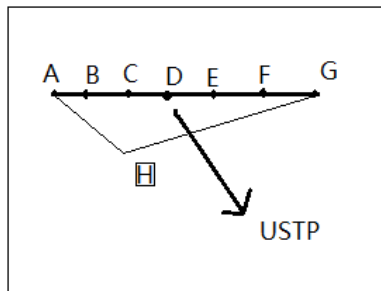

Operational details

1、 Select code data to add

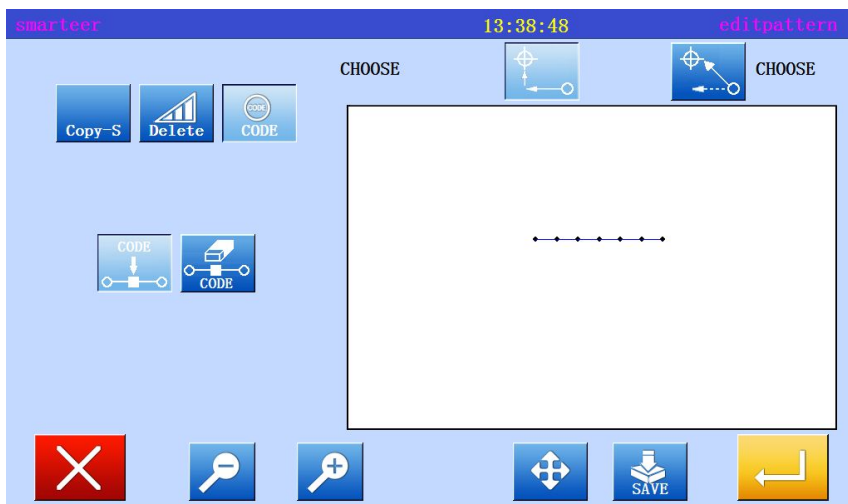

* Enter modify mode

* Press and .

* Press , open the next screen.

2、 Determine the location of the code to add

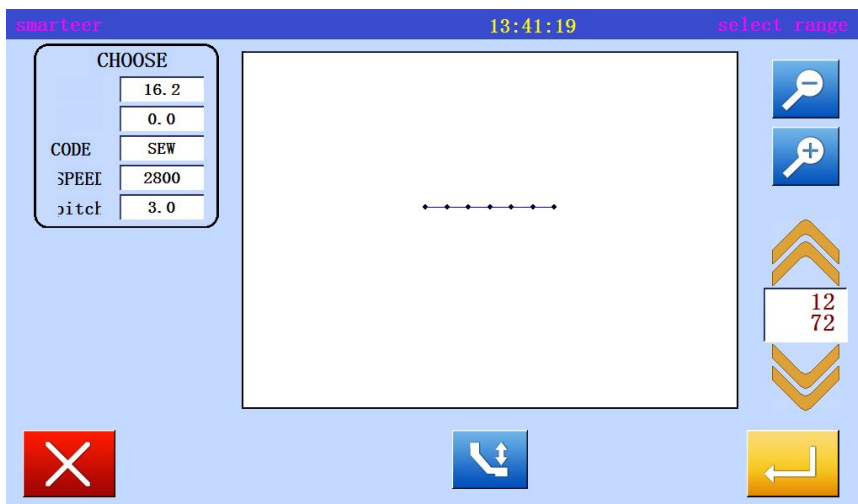

* Used to determine the location of the code to add (D point)

* Press .

3、 Set add code

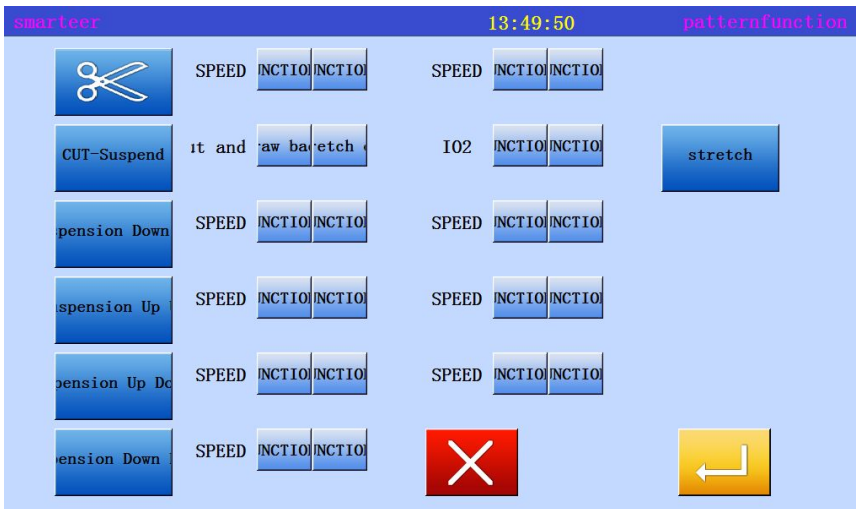

* Press .

4、 Confirm execution

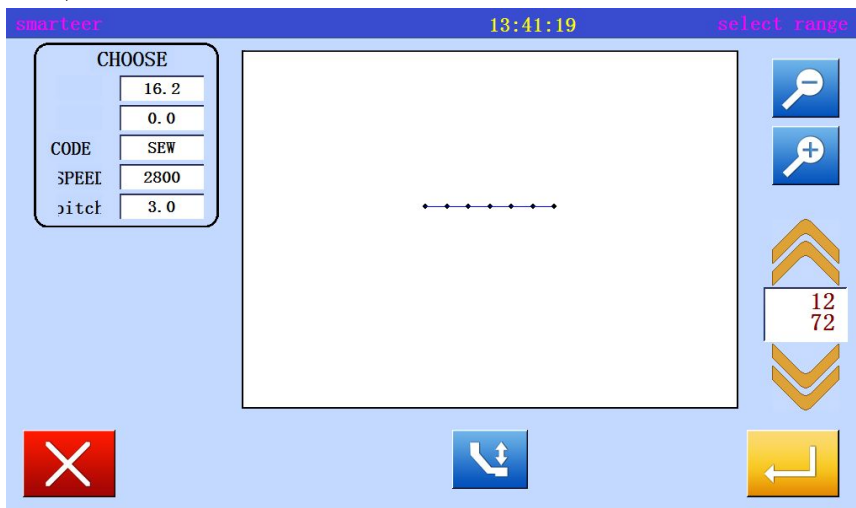

* Press .

5、 Confirm modification

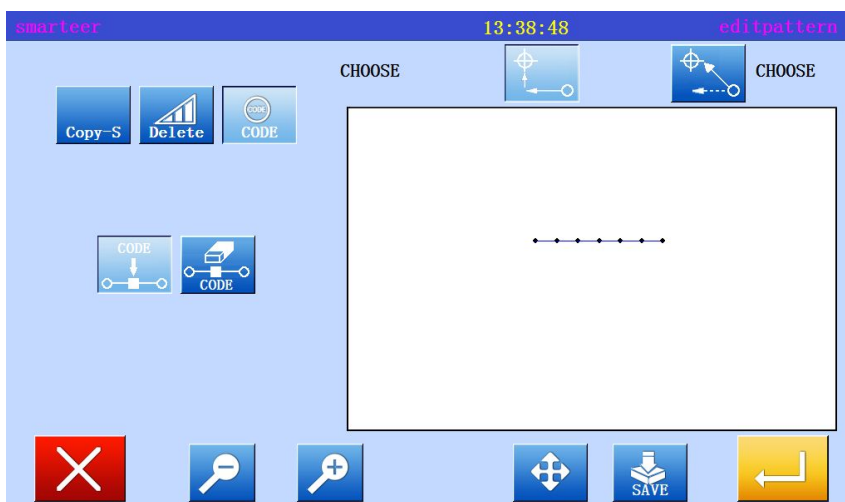























* Exit modification mode.

Press  to return to the standard screen.

[5]. Data transformation model

(1) Main data conversion mode

Function	Key	Details	Detail setting
In situ correction [5]-3		Set the number of in situ correction	 Fixed valid (setting position data)  Invalid correction
Seam reinforcement [5]-5		Can modify the existing reinforcement Can set up the existing reinforcement	 Start / end reinforcement  Overlap reinforcement (closed type)
Zigzagsewing [5]-9		Can modify the zigzagsewing step Can set up the zigzagsewing step	--
Graphics zoom [5]-12		The X and Y axis to the center point as the center, to zoom alone, set a fixed and fixed number of needle stitch	<div style="display: flex; justify-content: space-between;"> <div style="width: 45%;"> <p>< center point ></p>  Mobile instruction</div> <div style="width: 45%;">  number fixed</div> </div> <div style="display: flex; justify-content: space-between;"> <div style="width: 45%;">  Pattern center  In situ Center</div> <div style="width: 45%;">  pitch fixed</div> </div>
Symmetric [5]-15		Use existing sewing data, X axis, Y axis or XY axis, to establish a symmetrical pattern. Can also choose to retain or delete the existing sewing data.	<p>< Method</p>  Delete original symmetry  Keep original symmetry
Rotate [5]-17		The pattern can be any point as the center of rotation	<p>< center point ></p>  Mobile instruction  Pattern center  In situ Center
Deviation [5]-20		The offset distance and direction of the offset sewing data can be changed.	--
Multiple [5]-23		Multi layer distance, multi-layer direction, and multi-layer sewing number of multi-layer sewing data can be changed.	--

(2) Entry conversion mode



* Press  and  patternrotat

(3) Exit conversion mode

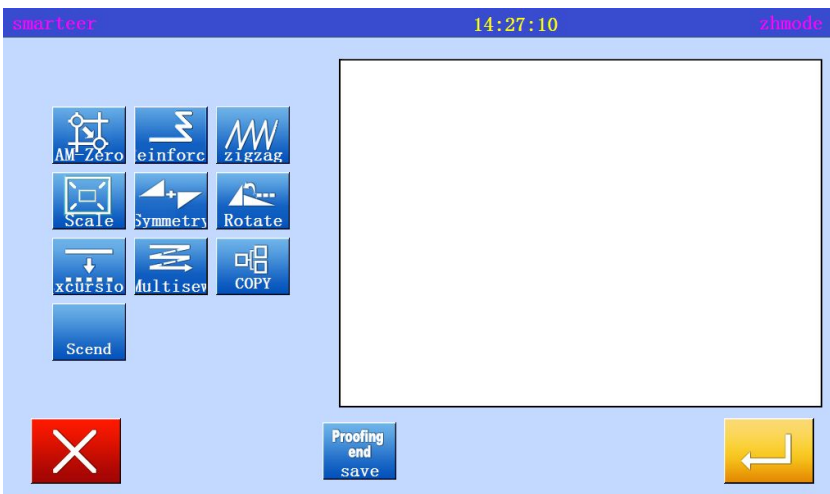

* After converting the data,
press  the exit conversion mode.

(4) Recognized in the image on the screen (conversion mode)

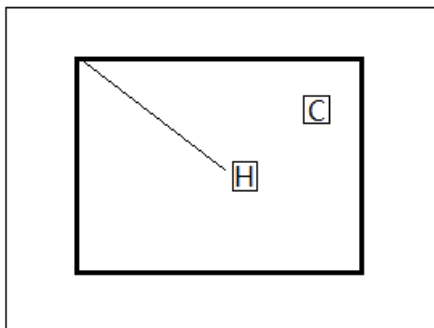

: Indicate in situ
(all image screens general)

: Center location

(5) Zero correction

[example] mechanical in situ can be increased by 0.1mm to move.

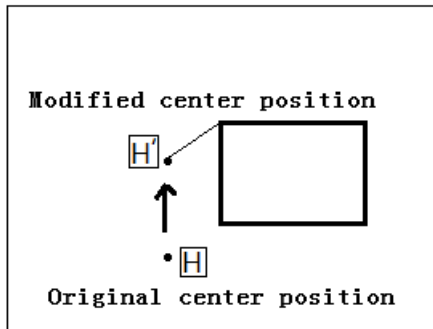

Operational details

1、 Select code data to delete

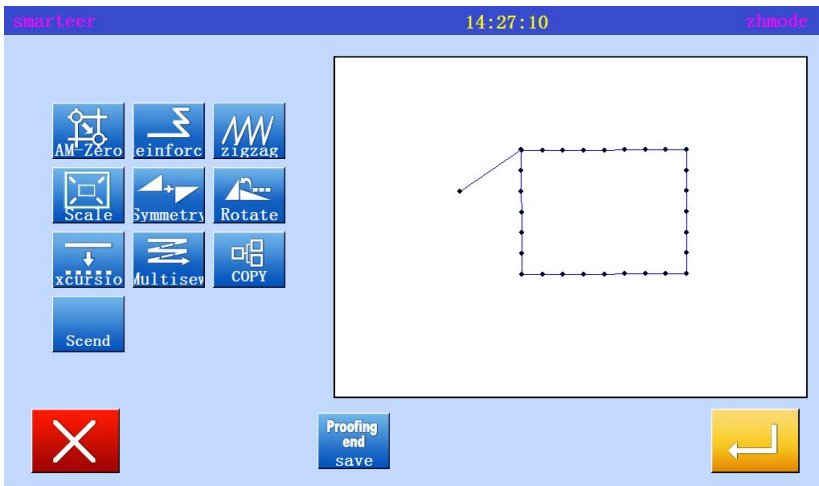

Enter the conversion mode

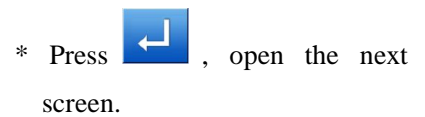

2、 Determine the location of the code to add

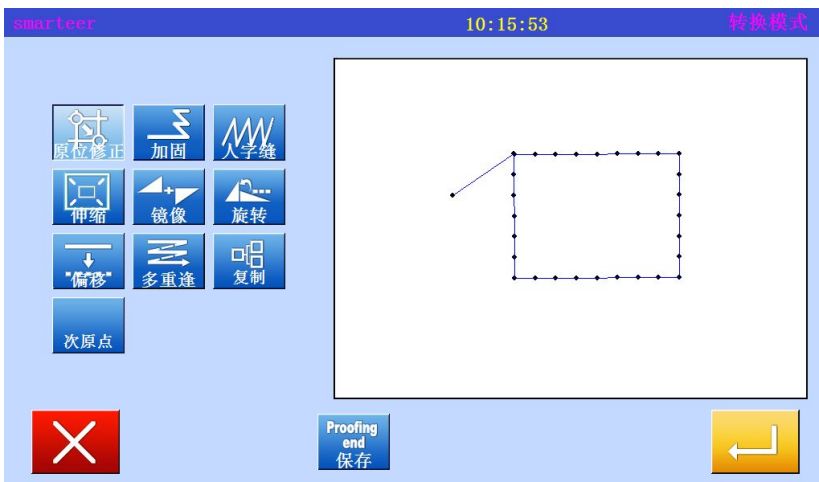

* Press zero "correction".

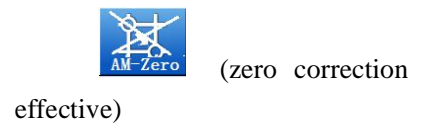

* Use the arrow keys to move to the set position, (from H to H')



3、Confirm conversion data

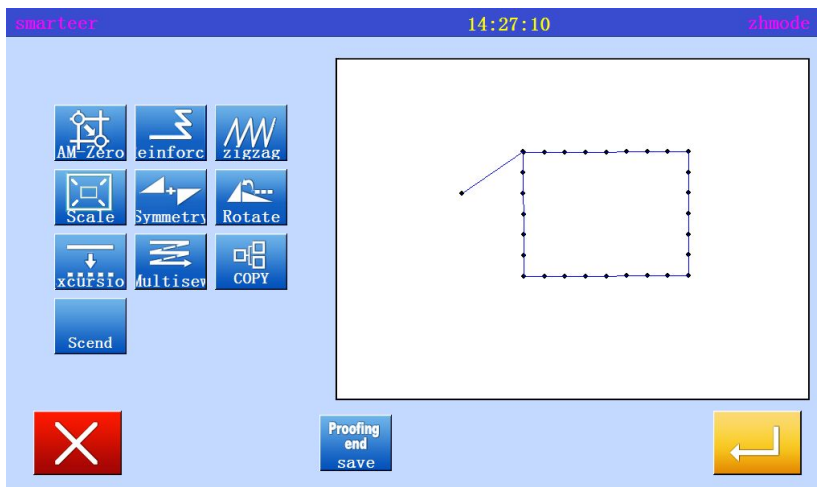

* After converting the data, press



the exit conversion mode.

(6) Reinforcement (start / end reinforcement)

[example] in the following types of sewing data, in sewing starting point (point a) and end (b) of the start / finish reinforcement is transformed (add) (deep black line represents the reinforcement)

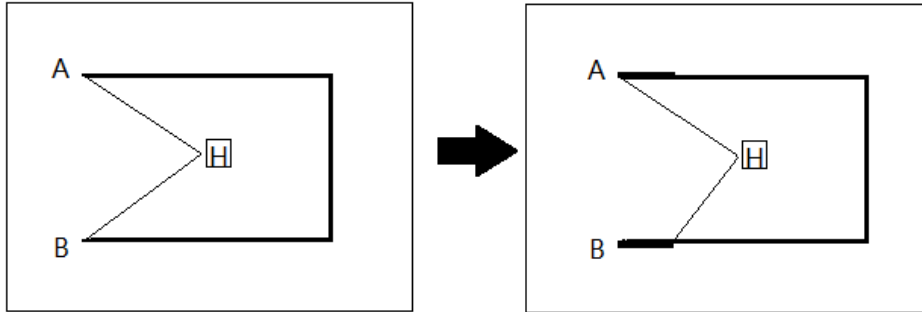

Operational details

1、 Selective reinforcement

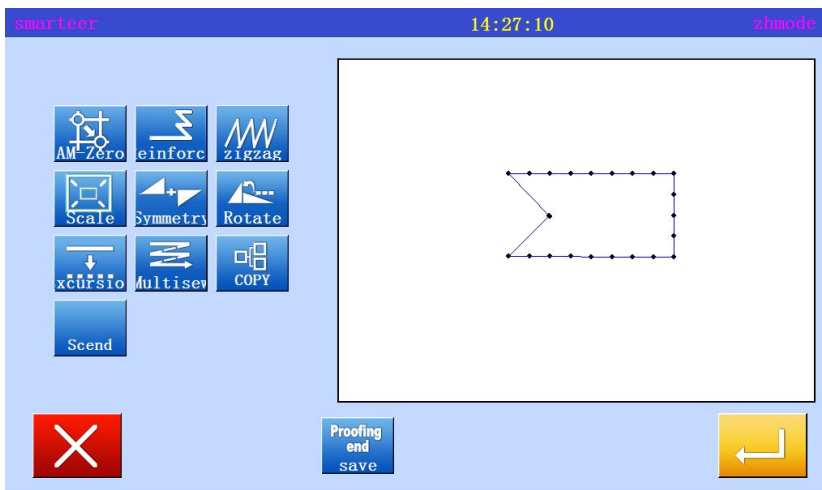



* Enter the conversion mode

* Press  加固。

* Press , open the next screen.

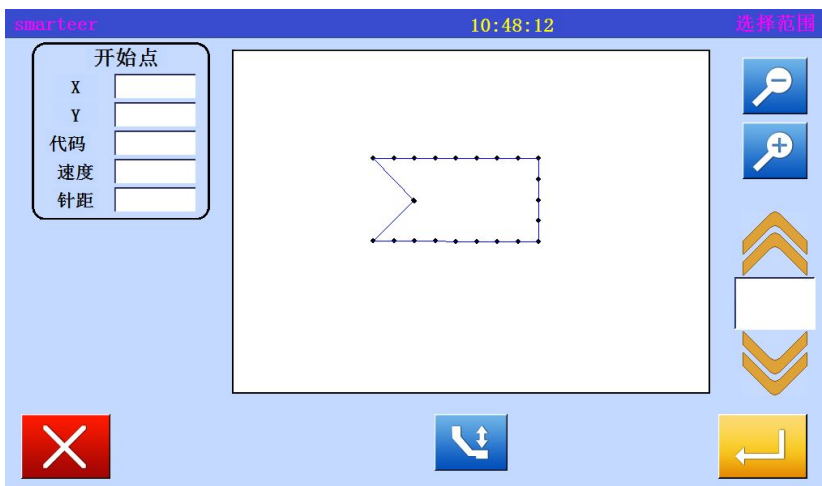
2、 Setting section, converting reinforcement



* Used  to move to the reinforcement of the section to be converted. Move to a point between A point and B point.

* Press .

3、Select Start / end reinforcement

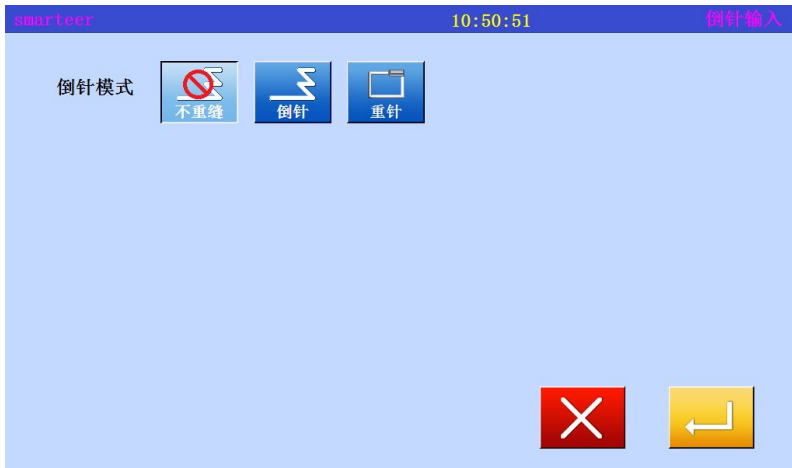

* Reinforcement at the beginning / end 。

4、Set Reinforcement Details

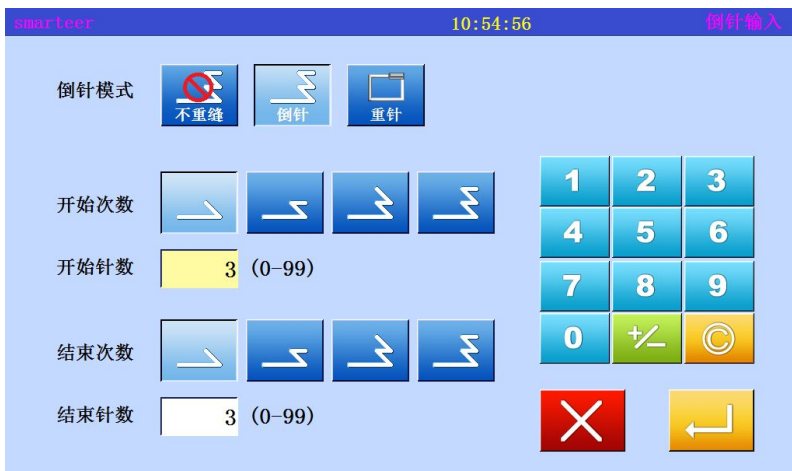

* Set details on this screen.

。(start / end reinforcement)

Start mode  (N mode), three inverted needle

End mode  (M mode), three inverted needle

* Press 。

5、Confirm conversion data

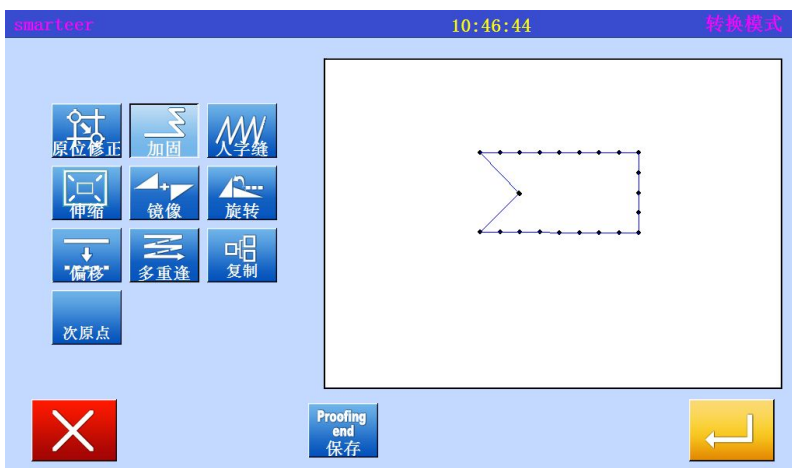

* After converting the data, press

 the exit conversion mode.

(7) Reinforcement (overlapping reinforcement)

[example] in the following types of sewing data, the overlap seam reinforcement is converted (added).

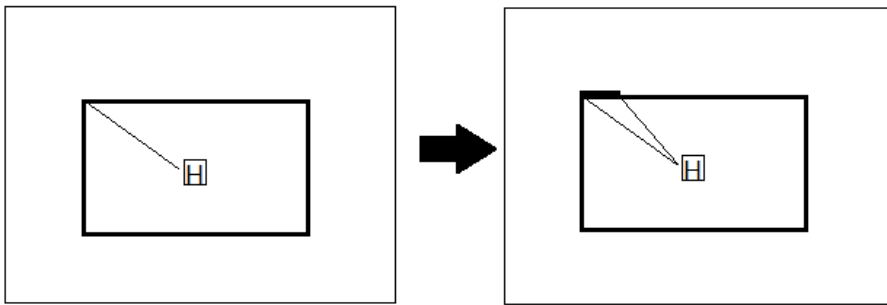

Operational details

1、 Selective reinforcement

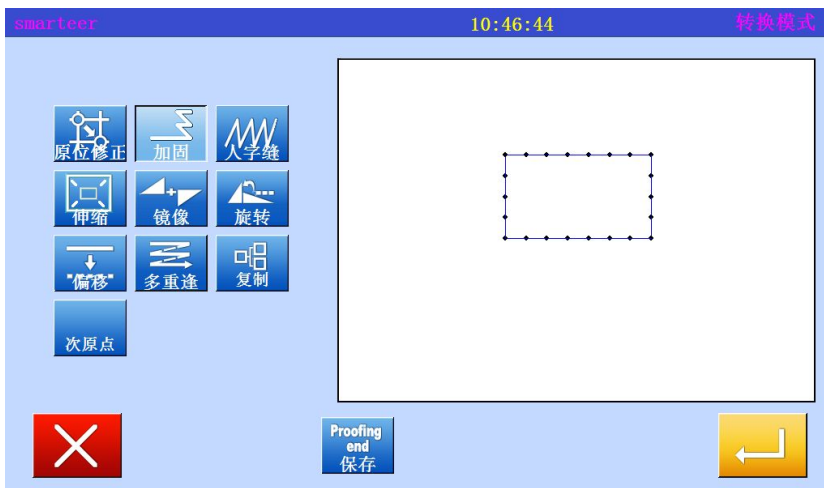



* Enter the conversion mode

* Press .

* Press , open the next screen.

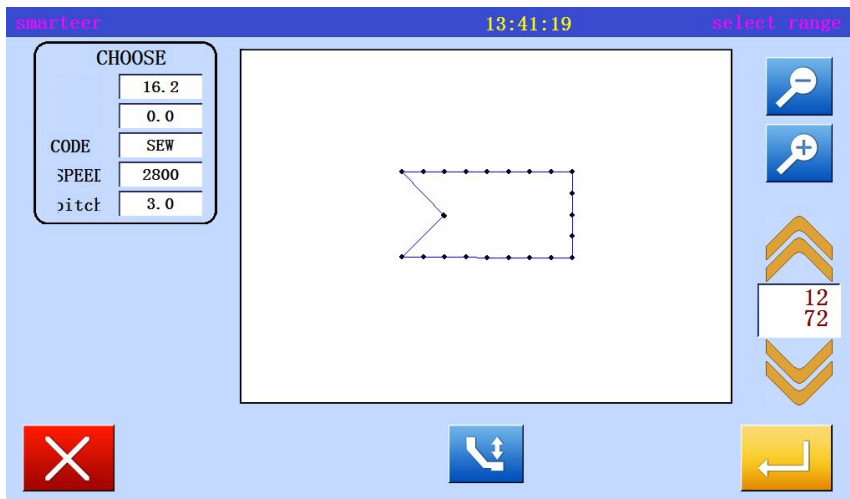
2、 Setting section, converting reinforcement



* Used  to move to the reinforcement of the section to be converted. Move to a point between A point and B point.

* Press .

3、 Select Start / end reinforcement

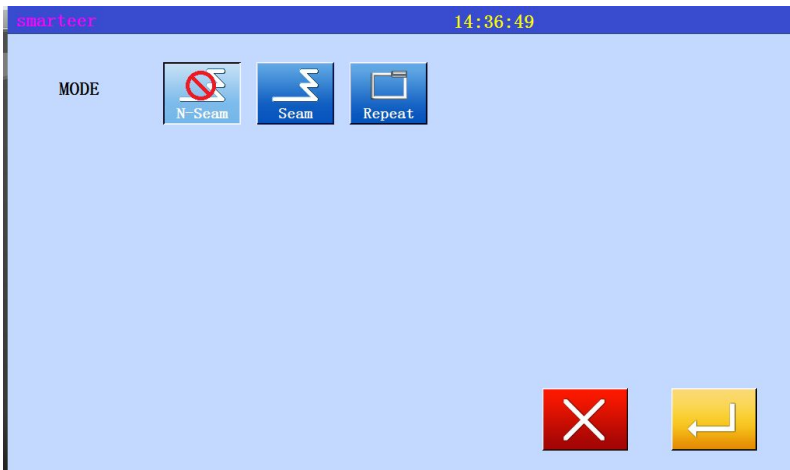



* Reinforcement at the beginning

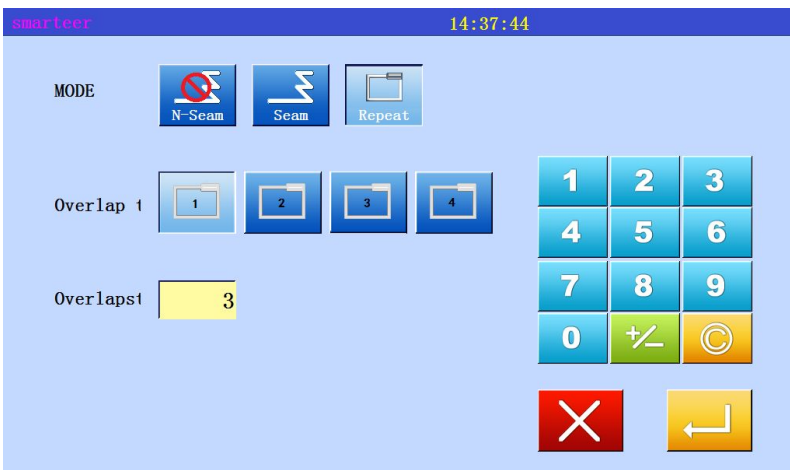

4、 Set Reinforcement Details



* Set details on this screen.

( 。 Overlapping reinforcement) Overlapping mode (), Three overlapping sewing.)

* Press  .

5、 Confirm conversion data

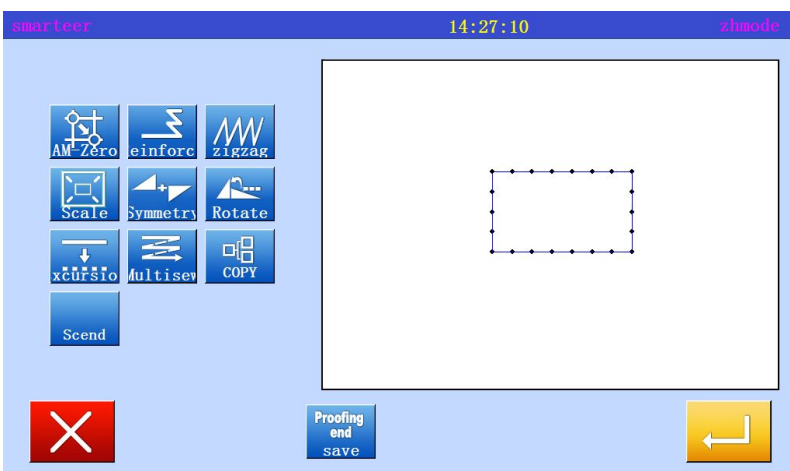

* After converting the data, press

 the exit conversion mode.

(8) Zigzagsewing

[example] in the following types, the curve between the B point and the C point is converted (add) to the zigzag.

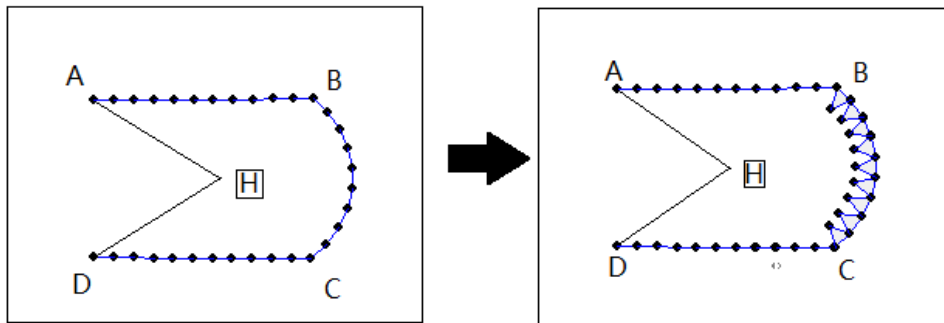

Operational details

1. Choose zigzagsewing

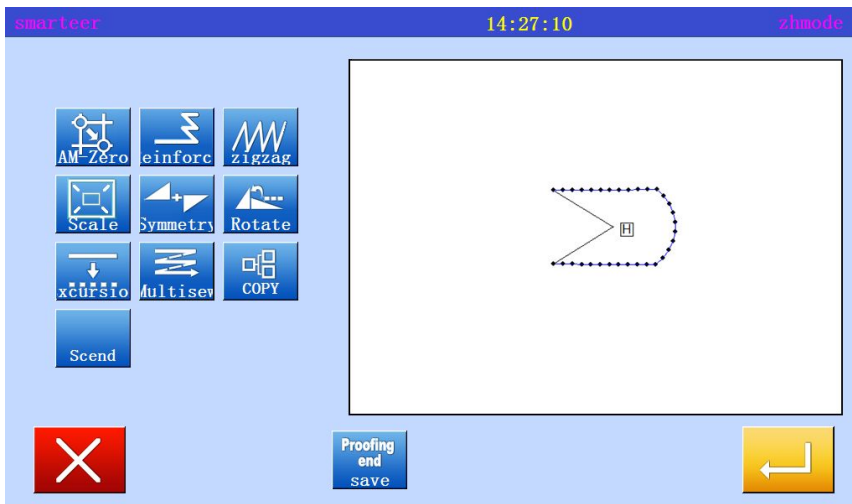



* Enter the conversion mode

* Press .

* Press , open the next screen.

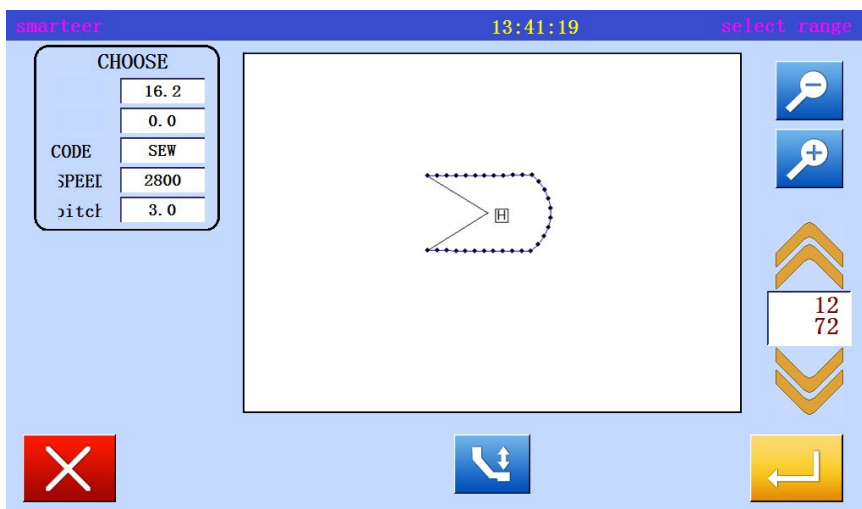
2. Set the conversion zigzag section



* Used  to move to the section on the transformation of zigzagsewing.

(Move to the curve section (point between B and C points).

* Press .

3、 Select the zigzag



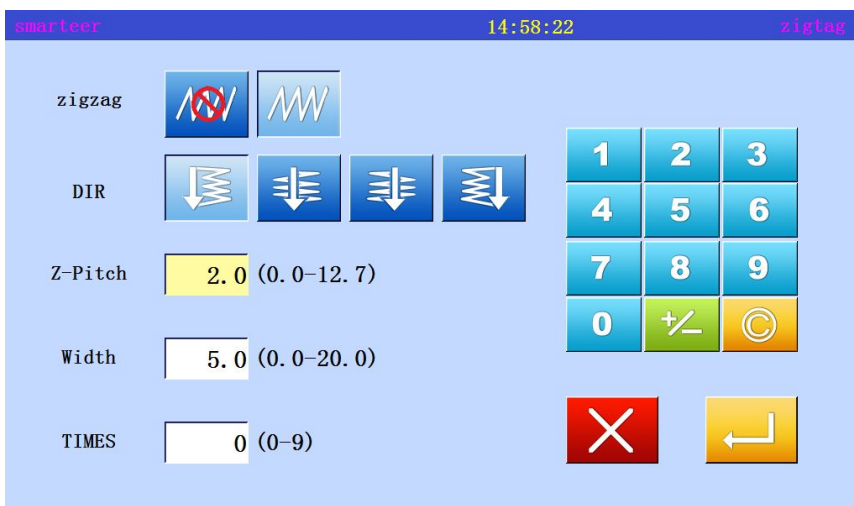

* Press .

4、 Set Reinforcement Details



* Set details on this screen

(Press , Set width: 5.0, herringbone stitch: 3.0, direction:  .)

* Press .

5、 Confirm conversion data

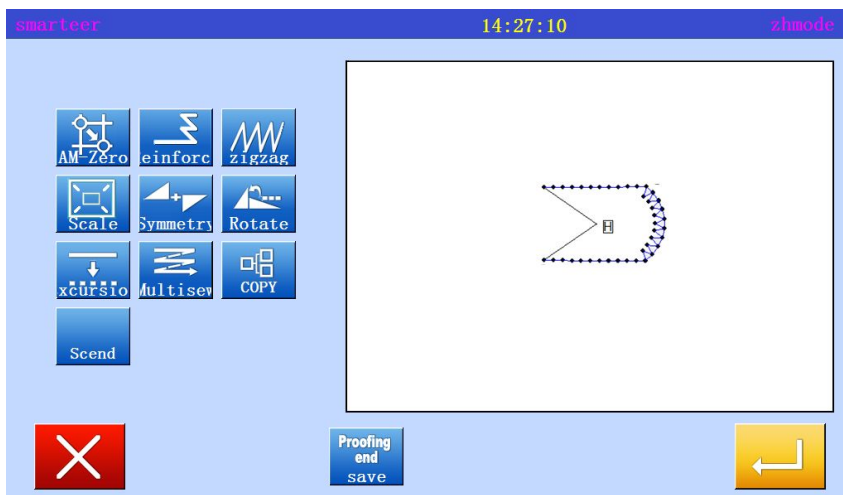

* After converting the data, press

 the exit conversion mode.

(9) Graphics zoom in and out

[example] in the following types, with the A point as the center, the pin is fixed, the number of stitches will be reduced (X:50%, 75%).

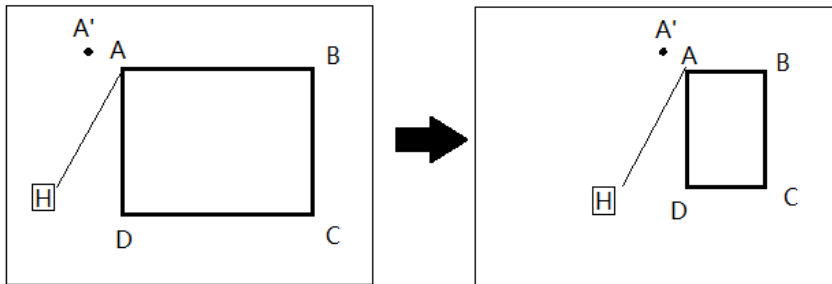

Operational details

1、 Select zoom

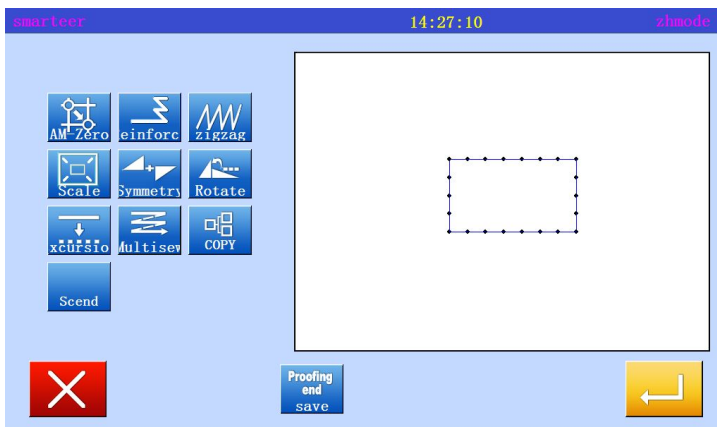

2、 Set zoom mode



* Entry conversion mode

* Press "  Scale .

* Press  .

* Mode

The number of needle fixed



Pitch fixed 

* With the number keys or up / down arrow keys to set the X, Y expansion / reduction percentage.

* Center designation



Mobile center

designation



Pattern center



Zero Center

(In this case, the mobile center is specified)

3、Set center position

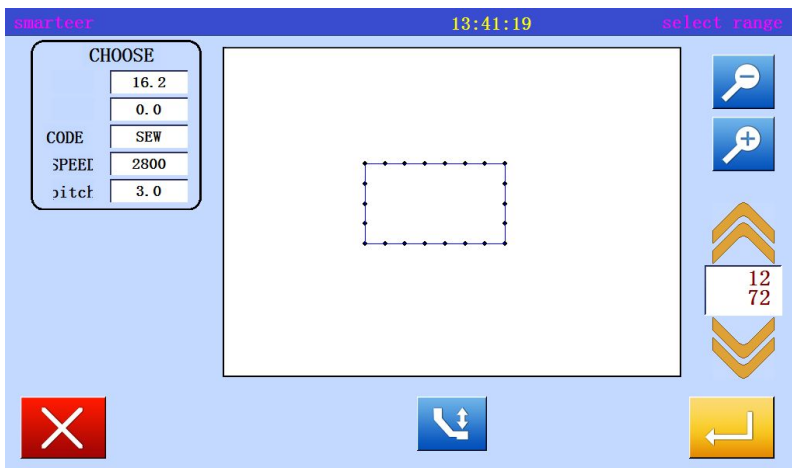

* In the moving mode, move to the position near the center of the expansion / reduction.
(in this case, moved to A 'near A point)

* Press .

You can specify a center point without using the move

key .

Press .

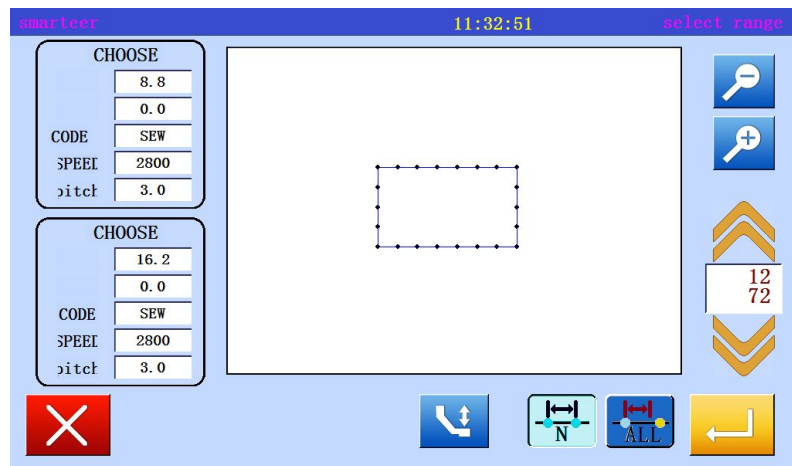

* If the center is not set for sewing data, use the arrow keys to move to the center position (A 'point).

4、Set center position

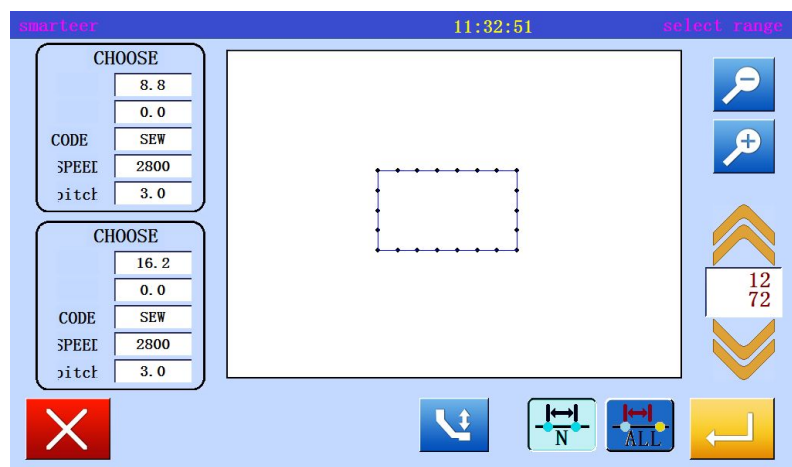

* Press .

5、 Confirm conversion data

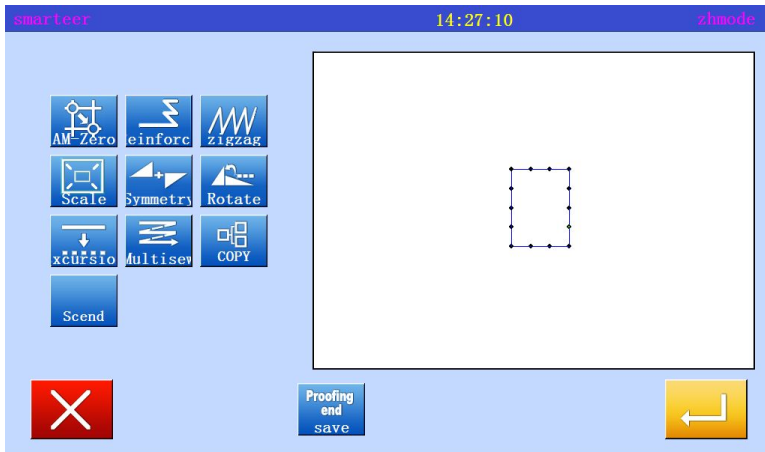

* After converting the data, press



the exit conversion mode.

Memo 1 Graphics zoom in.

B data (600–799) when the horizontal and vertical ratio is not at the same time, it will produce a positive circle.

Type BA data (400–499), type A data (100–299)

When the horizontal and vertical ratio is not at the same time, it will produce an oval shape.

Memo 2 Zigzag, multi line and zoom from the sideline.

Using the B data type (600–799) amplification shrinks, Zigzagsewing will not be affected.

When the zoom from the touchline hours may change with the following settings.

- * "zigzag stitch" and "zigzag width"
- * Distance between multiple lines"
- * From the edge of the margins"

The use of "conversion catalog" conversion is recommended to replace the use of "modified" directory"

For example, figure [A] is a multiple line spacing 3mm, when magnified 2 times (200%), a figure [B] is 3mm spacing unchanged.

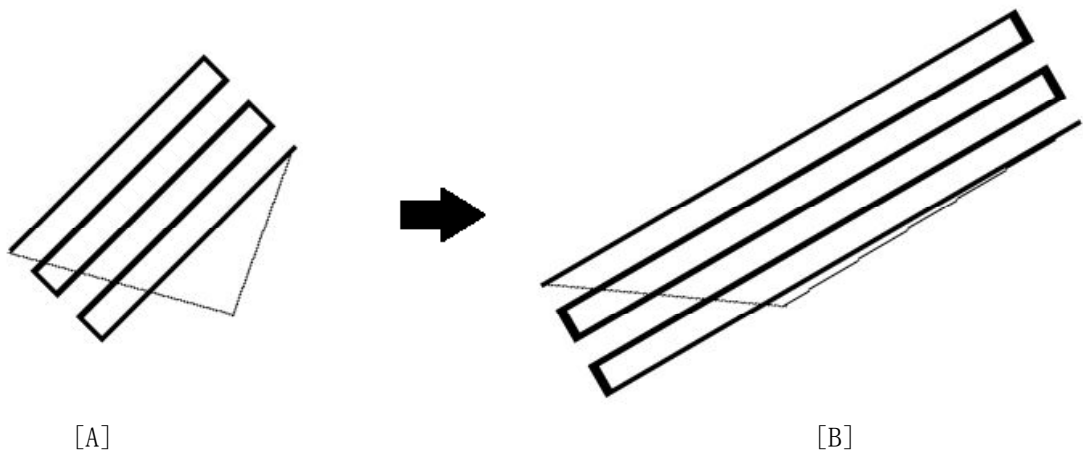

Memo 3 The use of B type data 600–799 as "pin fixed distance" and "pin fixed number" zoom in hours, amplify the reduced set will not affect the herringbone thread.

(10) Symmetry (mirror image copy)

[example] in the following types, the state is converted into the right state

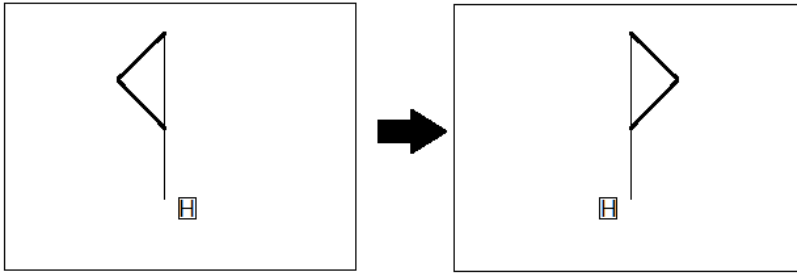

Operational details

1、Select objects

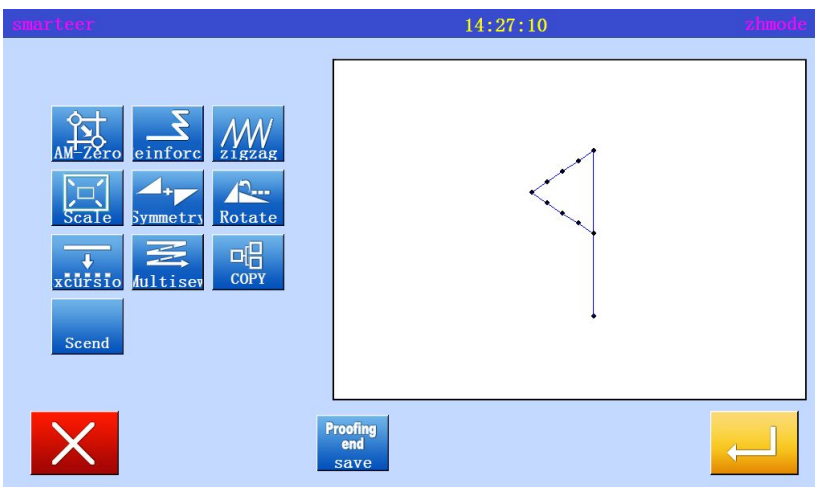

* Entry conversion mode



* Press "Symmetry".



* Press

2、Set symmetric mode, etc., and then execute

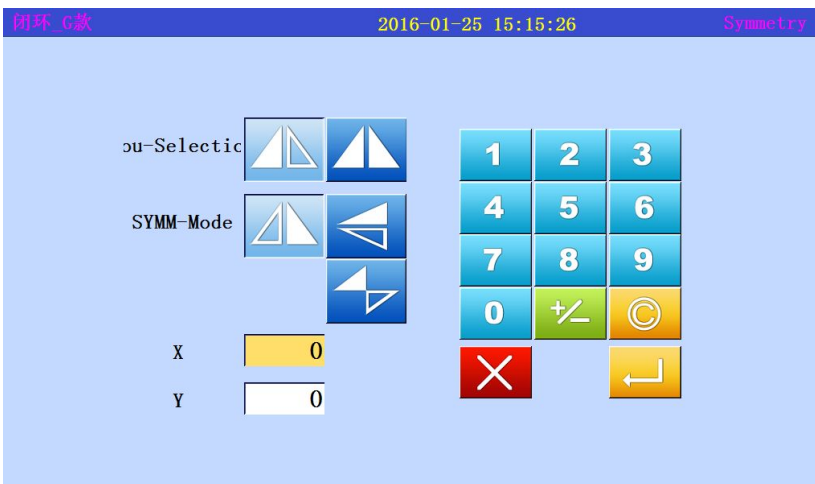

* Clear original symmetric data.



Clear symmetry of the original data



Preserve the original data (in this case, according to the "delete")

* Mode



X symmetric data



Y symmetric data



X、Y symmetric data (In this case, press X、Y symmetric data)



* Press

3、Confirm conversion data

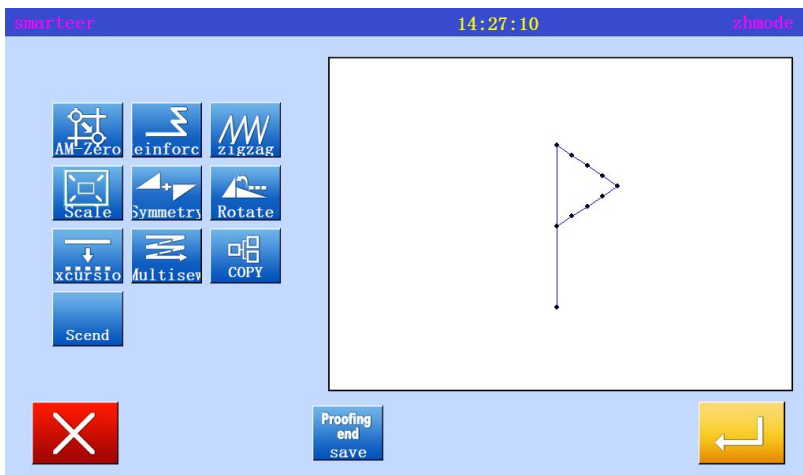

* After converting the data, press



the exit conversion mode.

(11) Rotate

[example] in the following types, with the A point as the center, rotate 45 degrees

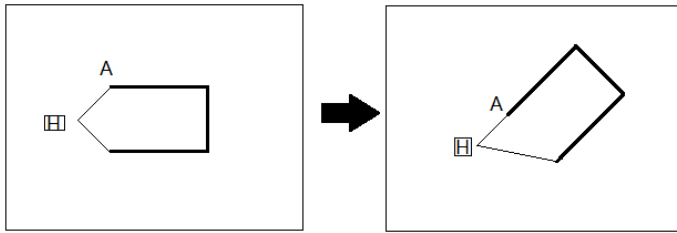

Operational details

1、 Selective rotation

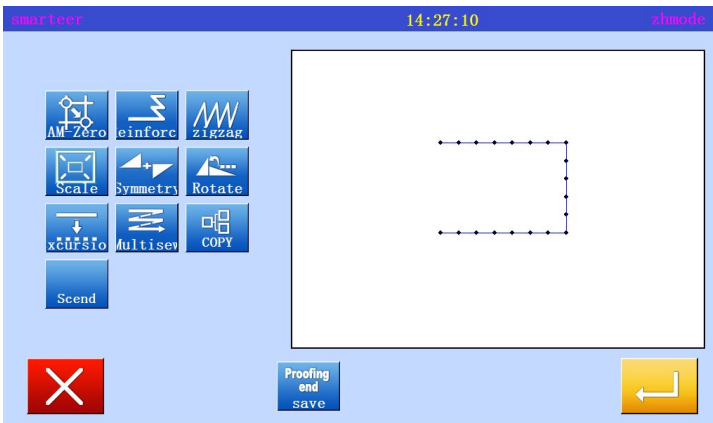

* Entry conversion mode



* Press ”



* Press

2、 Set rotation mode

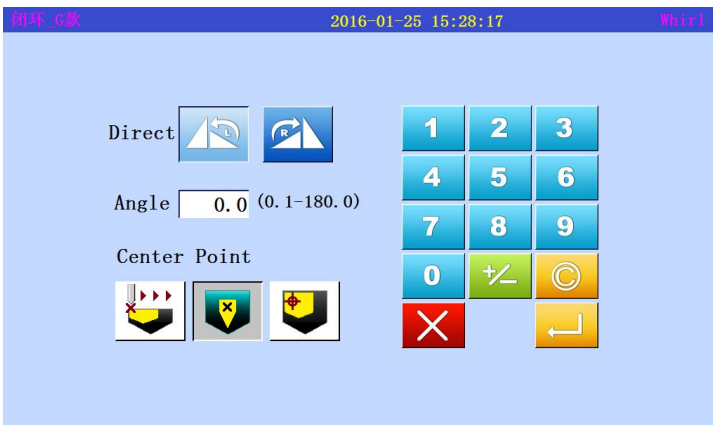

* Direction



Left rotation



Right rotation

(in this case, press the "left rotation")

* Angle From the point of view of digital key input (In this case, the input of 45 degrees)

* Center designation



Mobile center

designation



Pattern center



Zero Center

(the mobile center is specified)

3、Set center position

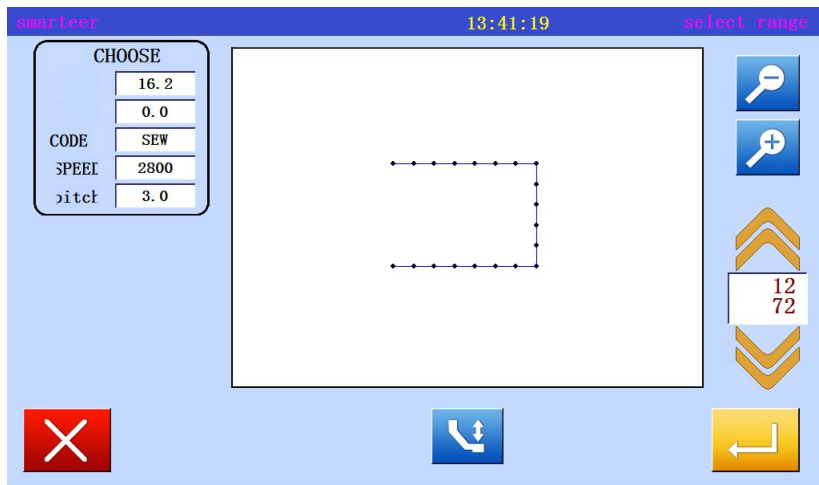

* Press  .

* In mobile mode, the needle is moved to the vicinity of the center of the needle.

* Press  .

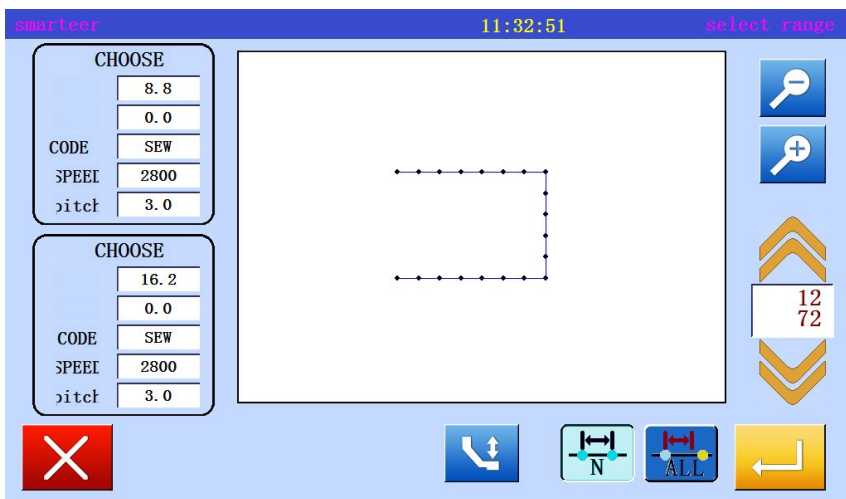

* If the center is not set for sewing data, use the arrow keys to move to the center. .

* After setting the center, press  .

4、Confirm conversion data

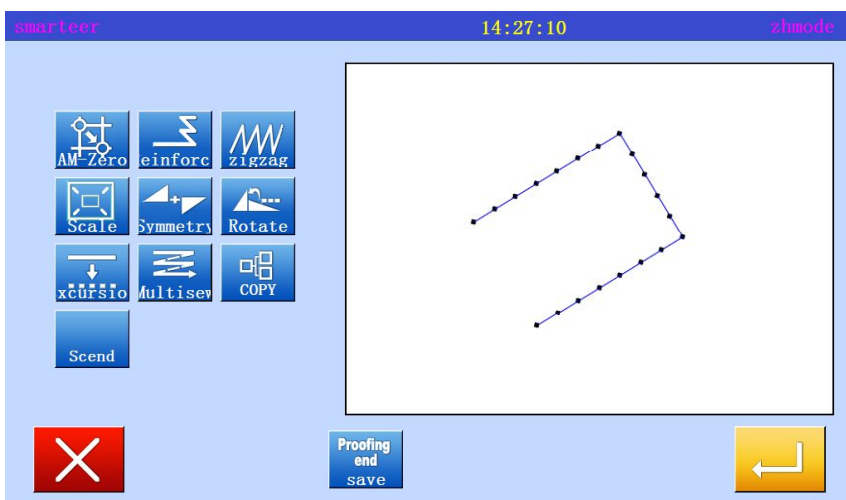

*After converting the data, press  the exit conversion mode.

(12) Deviation

[example] in the following types, the offset distance of the offset sewing A-B and C-D will be changed, converted to A'-B' and C'-D'.

The number is A-B:5mm, C-D:7mm, A'-B': 7mm, C'-D': 9mm

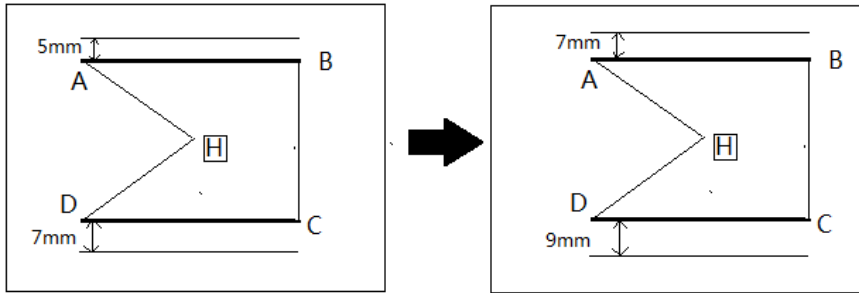

Operational details

1、Setting reinforcement

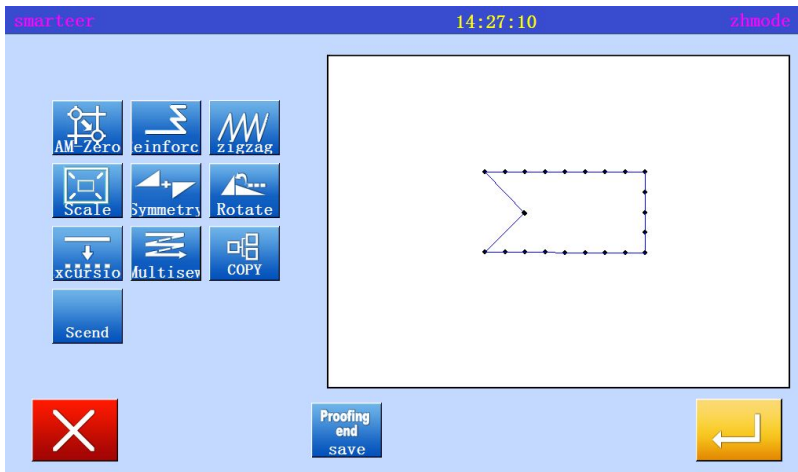

* Entry conversion mode

* Press "xcursio".

* Press [Enter]

2、Selection and confirmation of changes to the offset

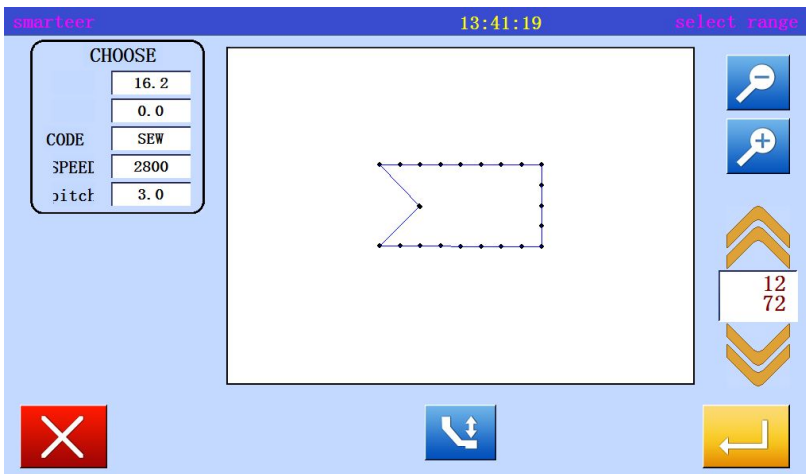

* Use [Up/Down Arrow], choose to change the offset

(in this case, select the first segment offset data.)

* Press [Enter].

3、Set Reinforcement Details



* Selection direction. (right)



Left direction

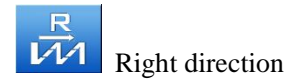

Right direction

* Input distance. (enter 7mm in this case.)

* Press .

4、Complete the first paragraph of the conversion

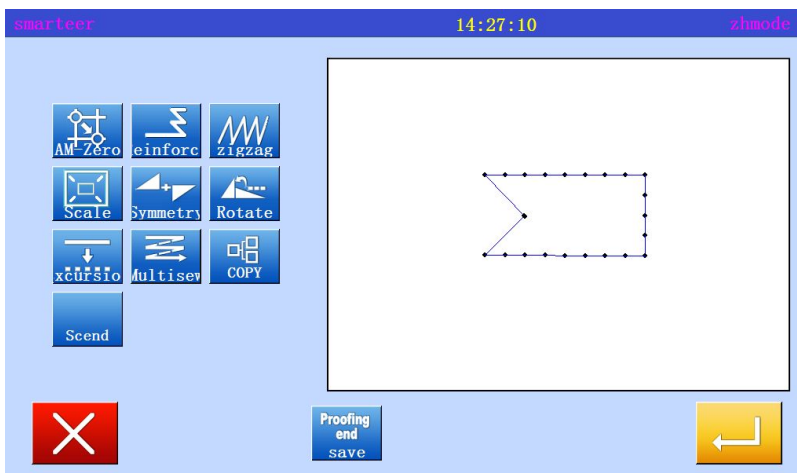

* Press  start second.

5、Select and confirm the next migration

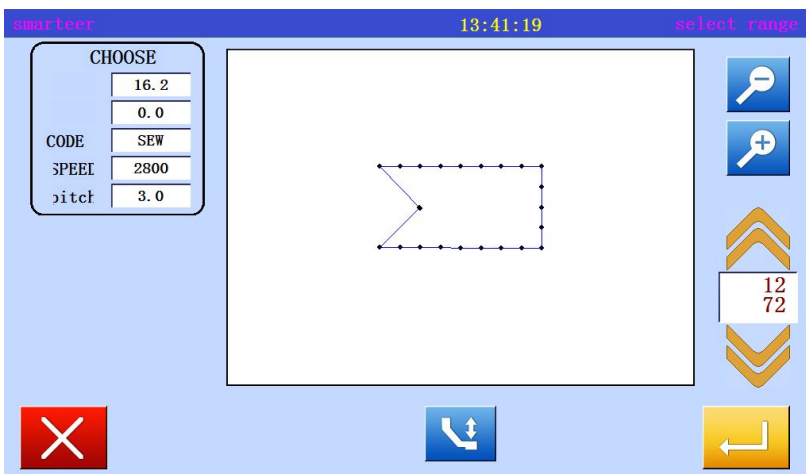

* Use arrow keys ,
Choose to change the offset.

* Press .

6、Setting and executing transformation mode



* Selection direction. (right here,)



Left direction



Right direction

* Input distance. (enter 9mm in this case,)

* Press .

7、Complete second segment conversion

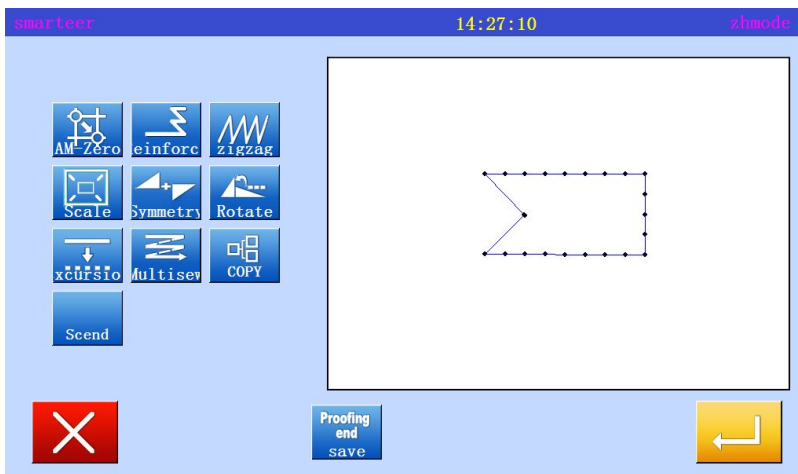

*After converting the data, press



the exit conversion mode.

.

(13) Multiple

[example] in the following types, the two designated ABCD into multiple sewing (transfer data specification), will be converted into ABC 'D' EF, designated three times into reverse multiple sewing (transfer data mode).

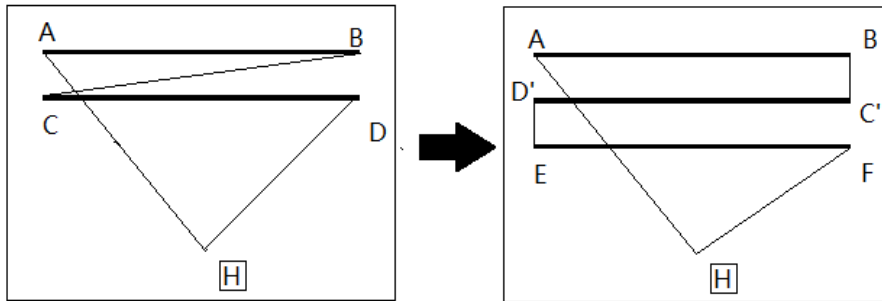

Operational details

1、Set multiple sewing

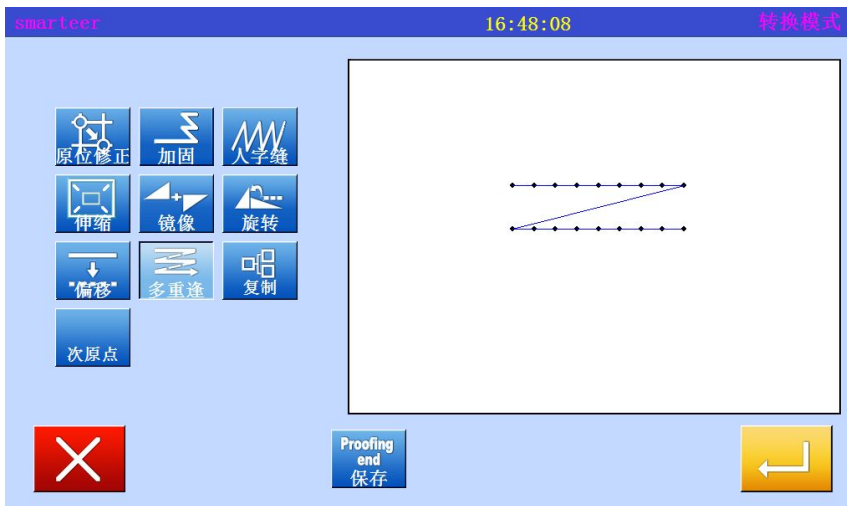

* Entry conversion mode



* Press "多重逢" 

* Press 

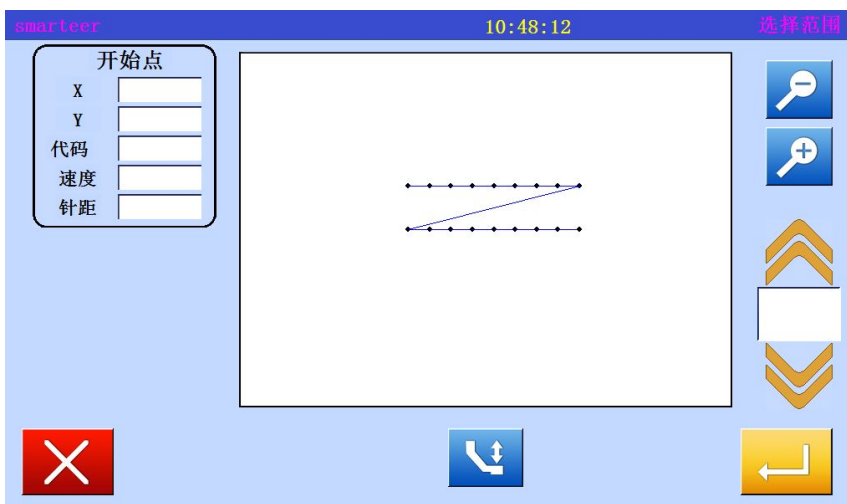
2、Setting mode, switching reinforcement



* If there are multiple settings,

Press the arrow keys  
(there will be multiple settings appear), change the settings.

* Press 

3、Set conversion mode



* Select and input multiple layers of sewing, direction, distance, and number of times



Multiple (empty send connection)



Multiple (Sewing connection)



Reverse multiple (empty send connection)

Reverse multiple (Sewing connection)

In this case, select “Multiple (Sewing connection)”

* Select the direction (in this case, select "right")



Left direction



Right direction

* Input range value (in this case, enter "10mm")

* Number of input (in this case, enter "3")

* Press 

4、Confirm conversion data

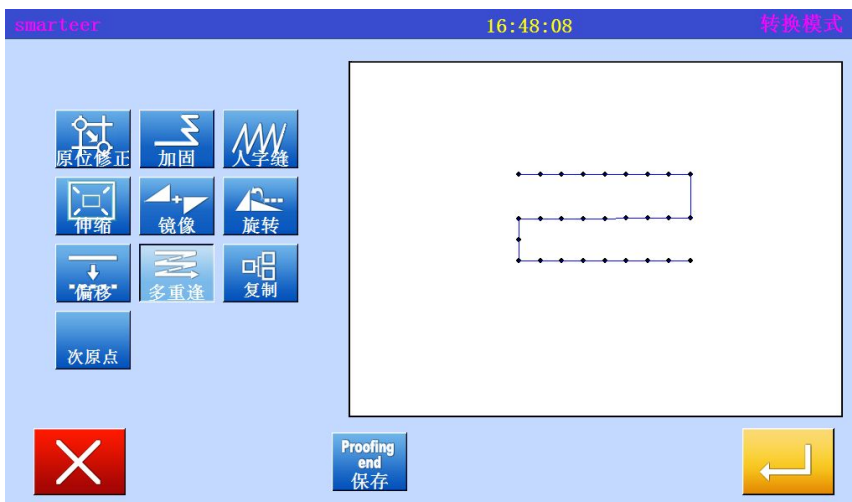

* After converting the data, press



the exit conversion mode.